

LMBS32 UU OP SAMICK

Linear bushing

TYPE: Shaft guidance systems, Linear bushing, Self aligning, Open type for support rail, Type LMBS..OP, American standard (SAMICK)

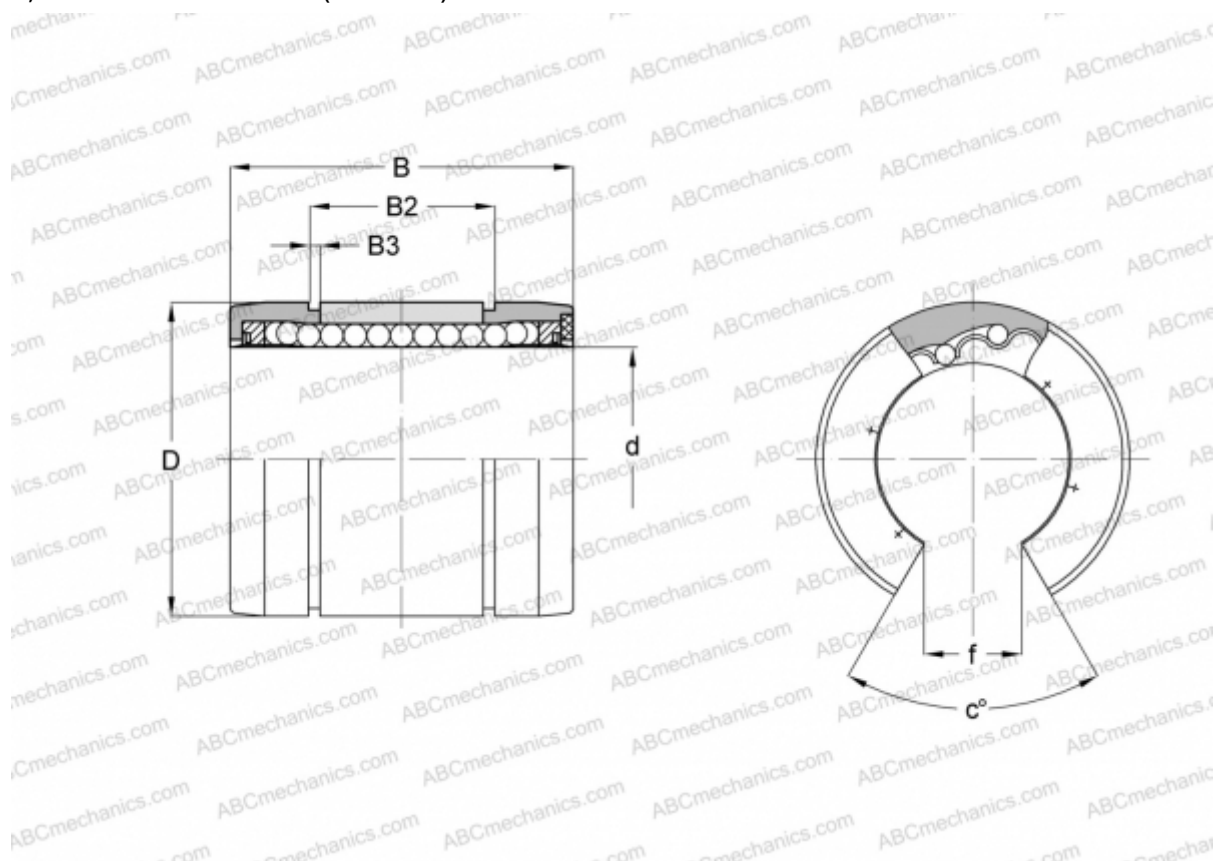

Technical specification

DIMENSIONS, MM

d	50,800
D	76,200
B	101,600
B2	81,102
B3	2,667
f	25,400
c	30

WEIGHT, KG 0,499

MANUFACTURER [SAMICK](http://www.samick.com)