

LME8 UU SAMICK

Linear bushing

TYPE: Shaft guidance systems, Linear bushing, Standard, Close type, Type LME, European standard, Plastic cage (SAMICK)

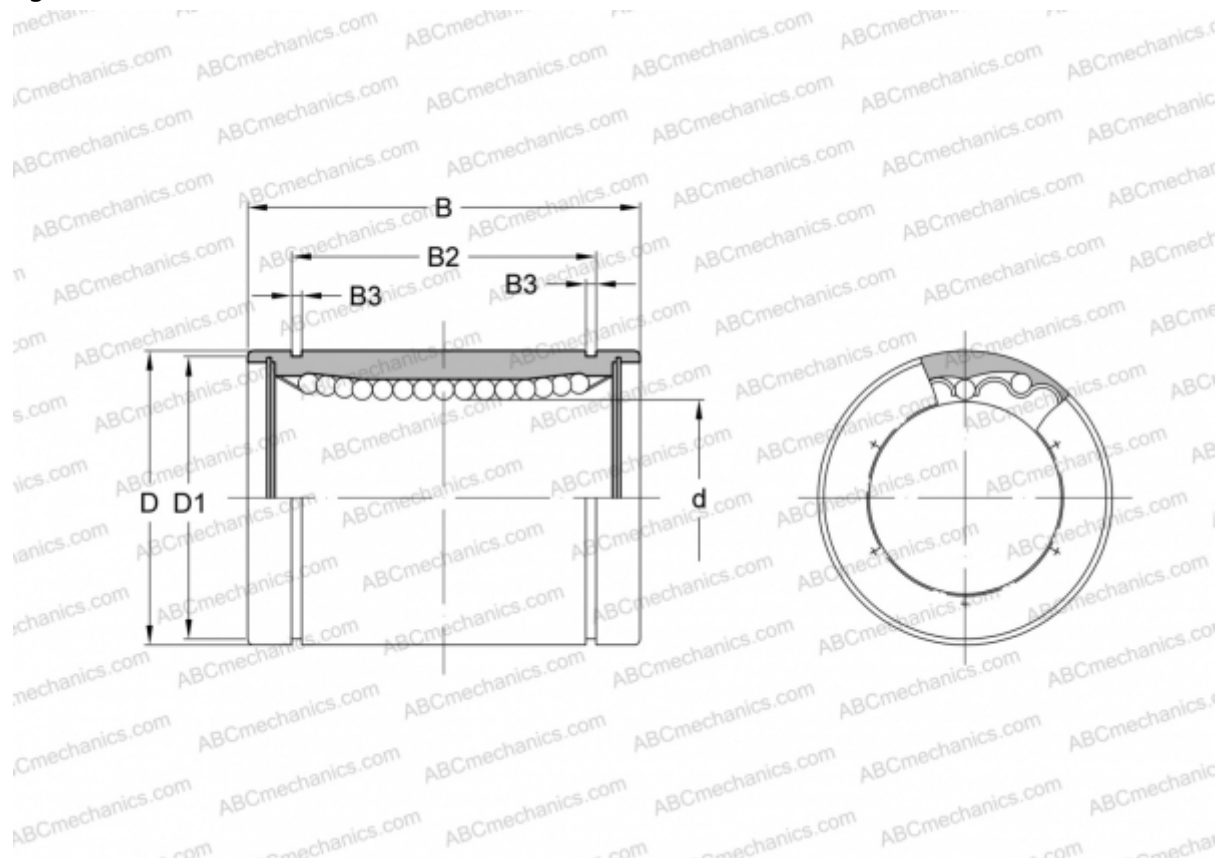

Technical specification

DIMENSIONS, MM

d	8,000
D	16,000
B	25,000
D1	15,200
B2	16,500
B3	1,100

WEIGHT, KG 0,020

MANUFACTURER [SAMICK](#)