

LME16 UU SAMICK

Linear bushing

TYPE: Shaft guidance systems, Linear bushing, Standard, Close type, Type LME, European standard, Plastic cage (SAMICK)

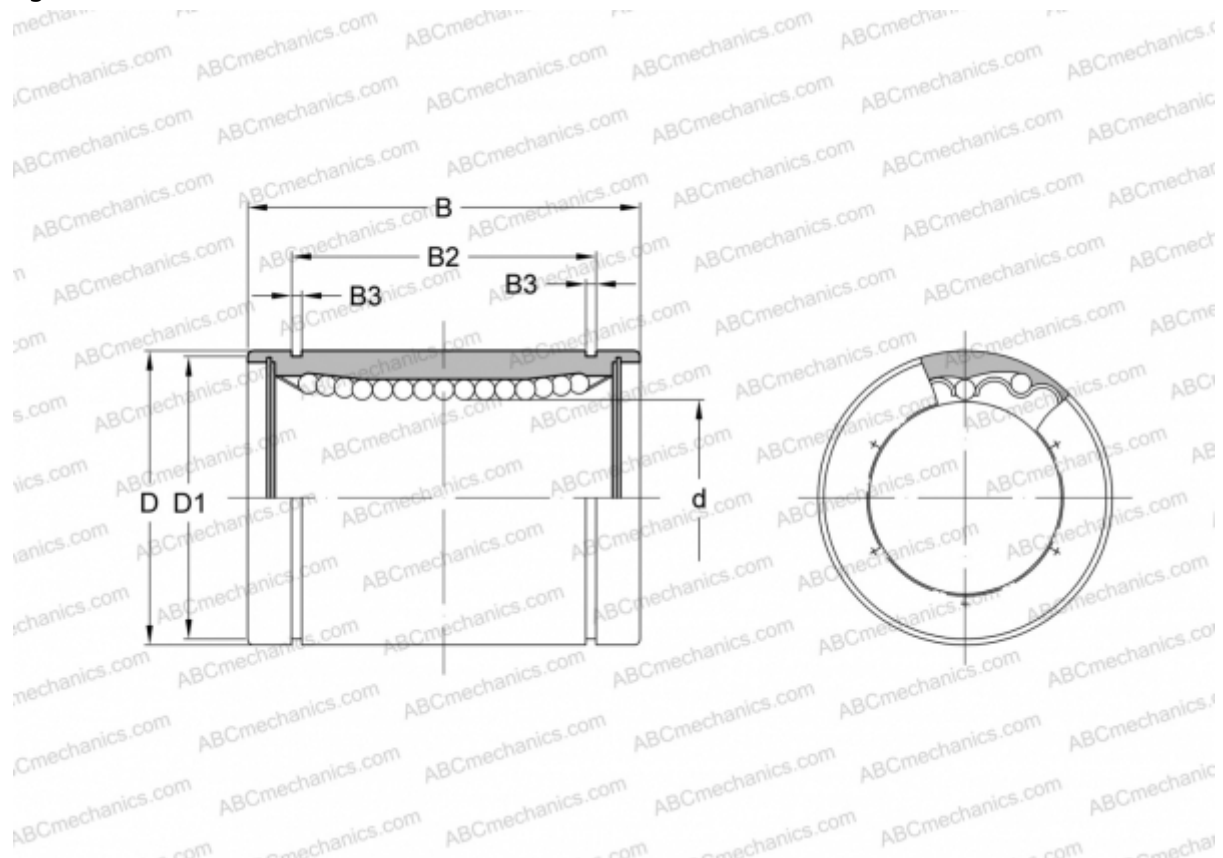

Technical specification

DIMENSIONS, MM

d	16,000
D	26,000
B	36,000
D1	24,900
B2	24,900
B3	1,300

WEIGHT, KG 0,057

MANUFACTURER [SAMICK](#)