

LM6 UU SAMICK

Linear bushing

TYPE: Shaft guidance systems, Linear bushing, Standard, Close type, Type LM, Asian standard, Plastic cage (SAMICK)

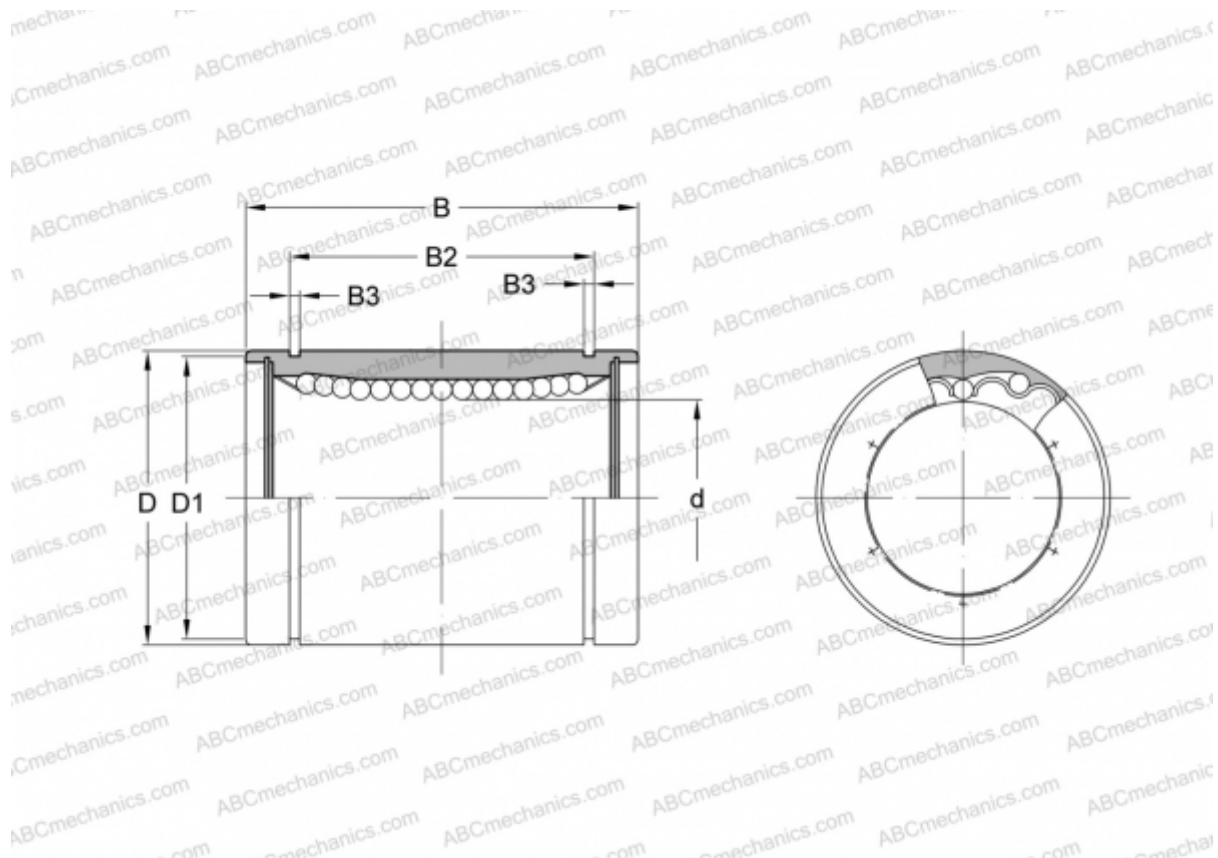

Technical specification

DIMENSIONS, MM

d	6,000
D	12,000
B	19,000
D1	11,500
B2	13,500
B3	1,100

WEIGHT, KG 0,008

MANUFACTURER [SAMICK](#)