

## LM8 UU SAMICK

Linear bushing

TYPE: Shaft guidance systems, Linear bushing, Standard, Close type, Type LM, Asian standard, Plastic cage (SAMICK)

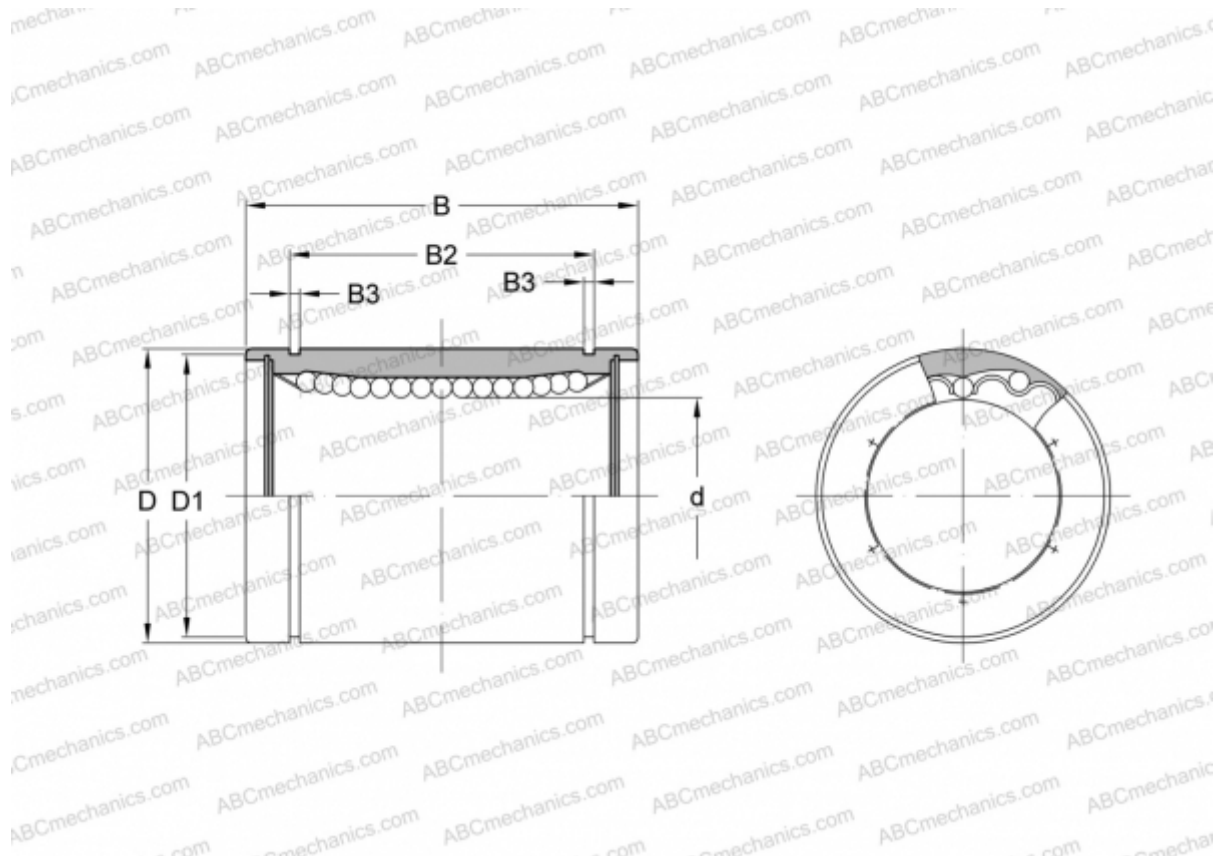

### Technical specification

#### DIMENSIONS, MM

d	8,000
D	15,000
B	24,000
D1	14,300
B2	17,500
B3	1,100

**WEIGHT, KG** 0,016

**MANUFACTURER** [SAMICK](#)