

LM13 UU SAMICK

Linear bushing

TYPE: Shaft guidance systems, Linear bushing, Standard, Close type, Type LM, Asian standard, Plastic cage (SAMICK)

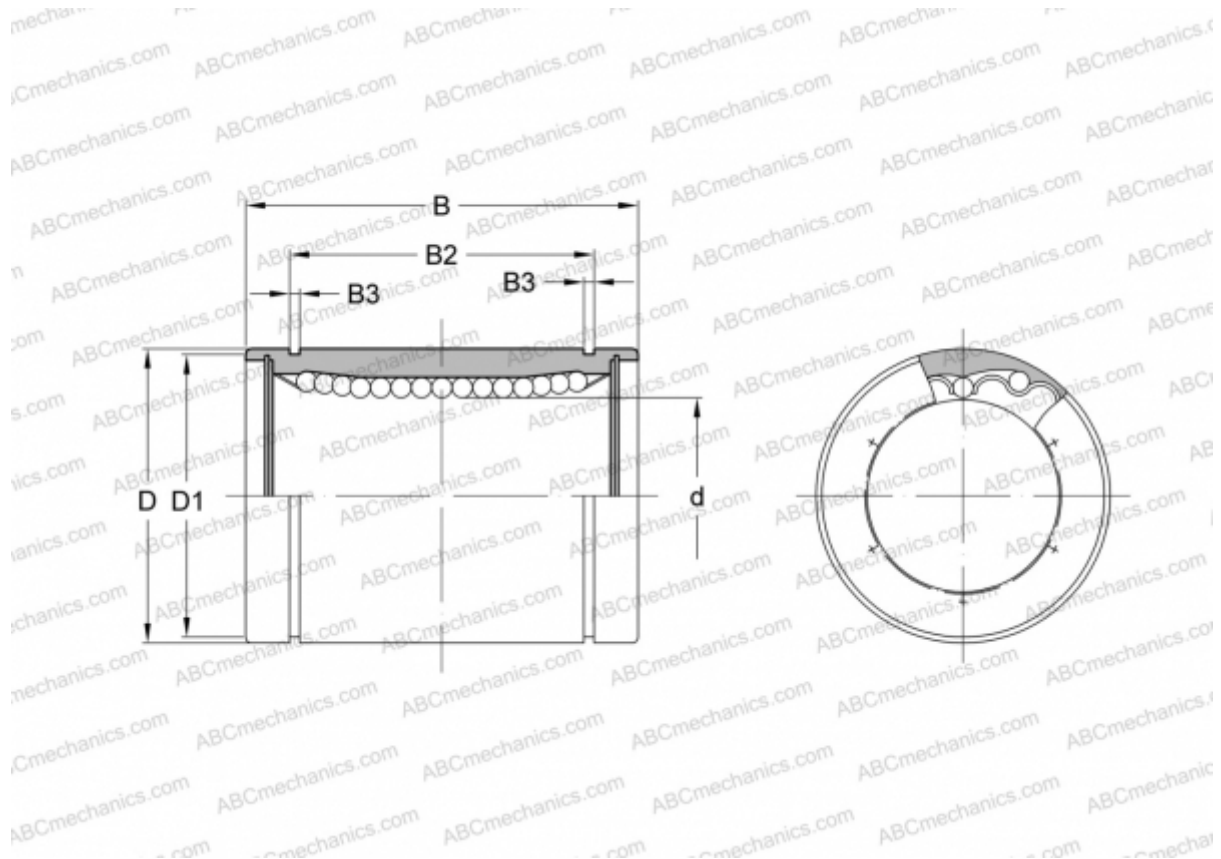

Technical specification

DIMENSIONS, MM

d	13,000
D	23,000
B	32,000
D1	22,000
B2	23,000
B3	1,300

WEIGHT, KG 0,043

MANUFACTURER [SAMICK](#)