

LM16 UU SAMICK

Linear bushing

TYPE: Shaft guidance systems, Linear bushing, Standard, Close type, Type LM, Asian standard, Plastic cage (SAMICK)

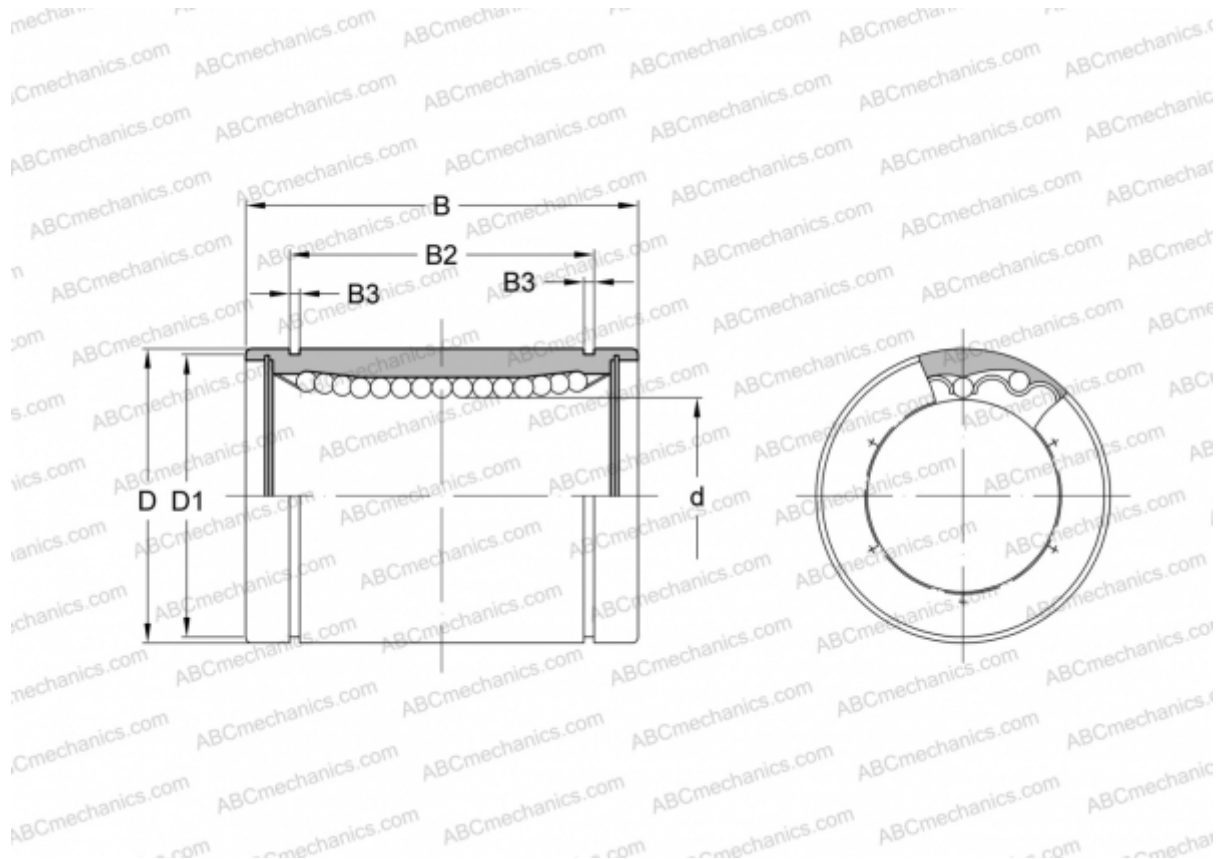

Technical specification

DIMENSIONS, MM

d	16,000
D	28,000
B	37,000
D1	27,000
B2	26,500
B3	1,600

WEIGHT, KG 0,069

MANUFACTURER [SAMICK](http://www.samick.com)