

## LM20 UU SAMICK

Linear bushing

TYPE: Shaft guidance systems, Linear bushing, Standard, Close type, Type LM, Asian standard, Plastic cage (SAMICK)

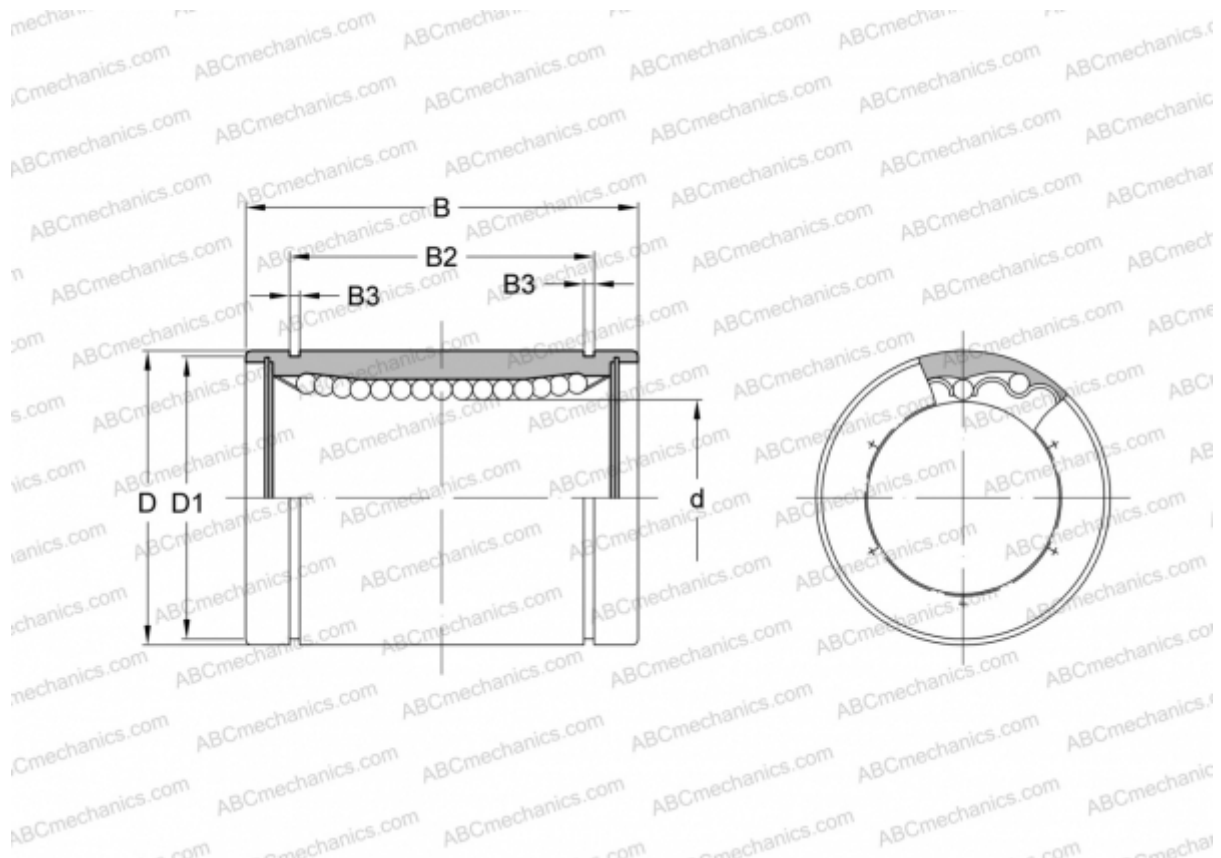

### Technical specification

#### DIMENSIONS, MM

d	20,000
D	32,000
B	42,000
D1	30,500
B2	30,500
B3	1,600

**WEIGHT, KG** 0,087

**MANUFACTURER** [SAMICK](#)