

LM60 UU SAMICK

Linear bushing

TYPE: Shaft guidance systems, Linear bushing, Standard, Close type, Type LM, Asian standard, Plastic cage (SAMICK)

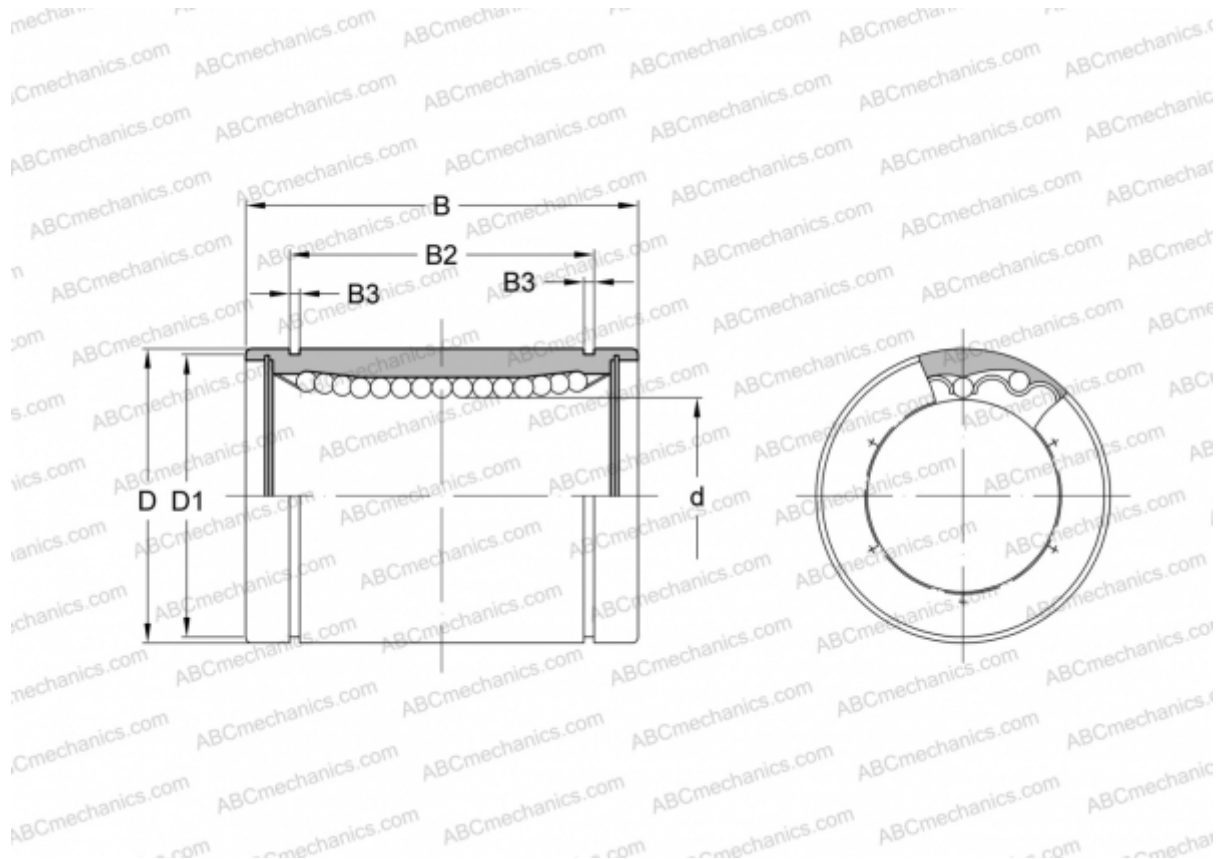

Technical specification

DIMENSIONS, MM

d	60,000
D	90,000
B	110,000
D1	86,500
B2	85,000
B3	3,150

WEIGHT, KG 2,000

MANUFACTURER [SAMICK](http://www.samick.com)