

LM8 UU A SAMICK

Linear bushing

TYPE: Shaft guidance systems, Linear bushing, Standard, Close type, Type LM, Asian standard, Steel cage (SAMICK)

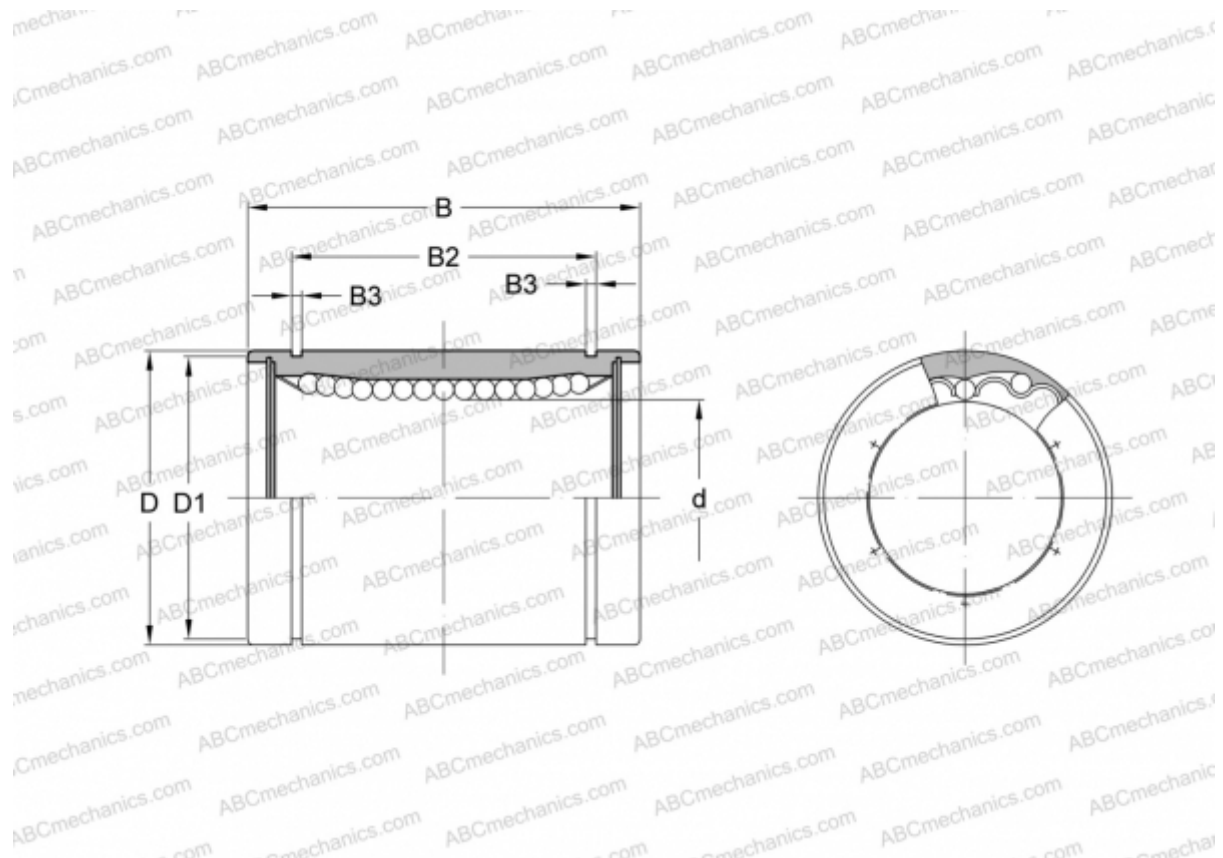

Technical specification

DIMENSIONS, MM

d	8,000
D	15,000
B	24,000
D1	14,300
B2	17,500
B3	1,100

WEIGHT, KG 0,016

MANUFACTURER [SAMICK](http://www.samick.com)