

LM25 UU A SAMICK

Linear bushing

TYPE: Shaft guidance systems, Linear bushing, Standard, Close type, Type LM, Asian standard, Steel cage (SAMICK)

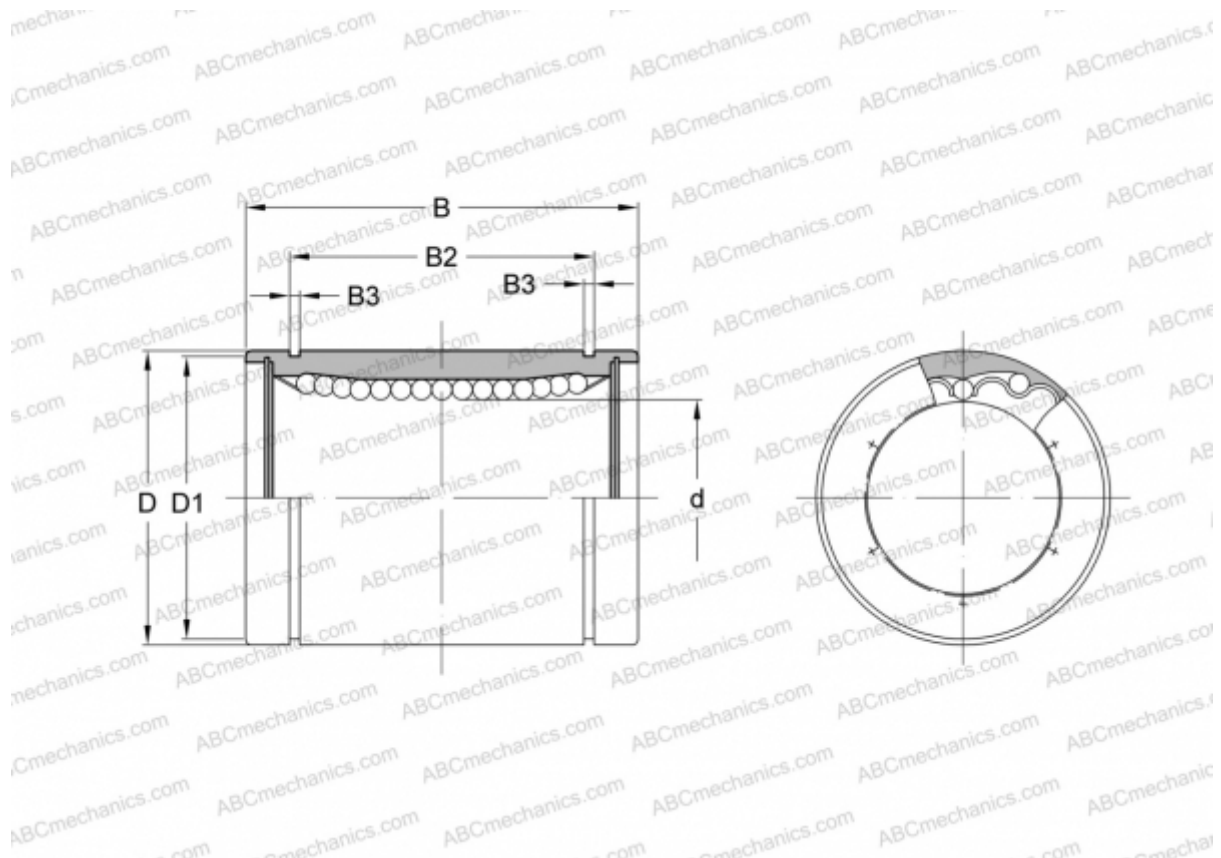

Technical specification

DIMENSIONS, MM

d	25,000
D	40,000
B	59,000
D1	38,000
B2	41,000
B3	1,850

WEIGHT, KG 0,220

MANUFACTURER [SAMICK](http://www.samick.com)