

LME16L UU SAMICK

Linear bushing

TYPE: Shaft guidance systems, Linear bushing, Standard, Close type, double length, Type LME..L, European standard, Plastic cage (SAMICK)

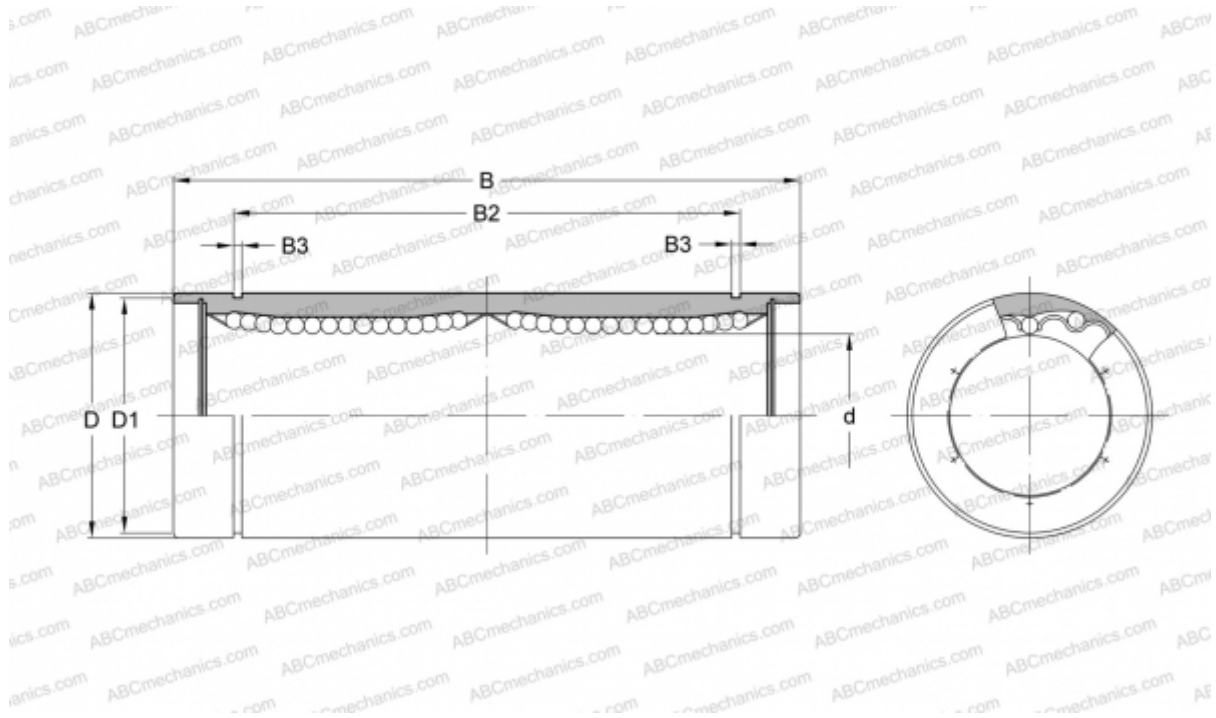

Technical specification

DIMENSIONS, MM

d	16,000
D	26,000
B	70,000
D1	24,900
B2	49,800
B3	1,300

WEIGHT, KG 0,145

MANUFACTURER [SAMICK](http://www.samick.com)