

LME25L UU SAMICK

Linear bushing

TYPE: Shaft guidance systems, Linear bushing, Standard, Close type, double length, Type LME..L, European standard, Plastic cage (SAMICK)

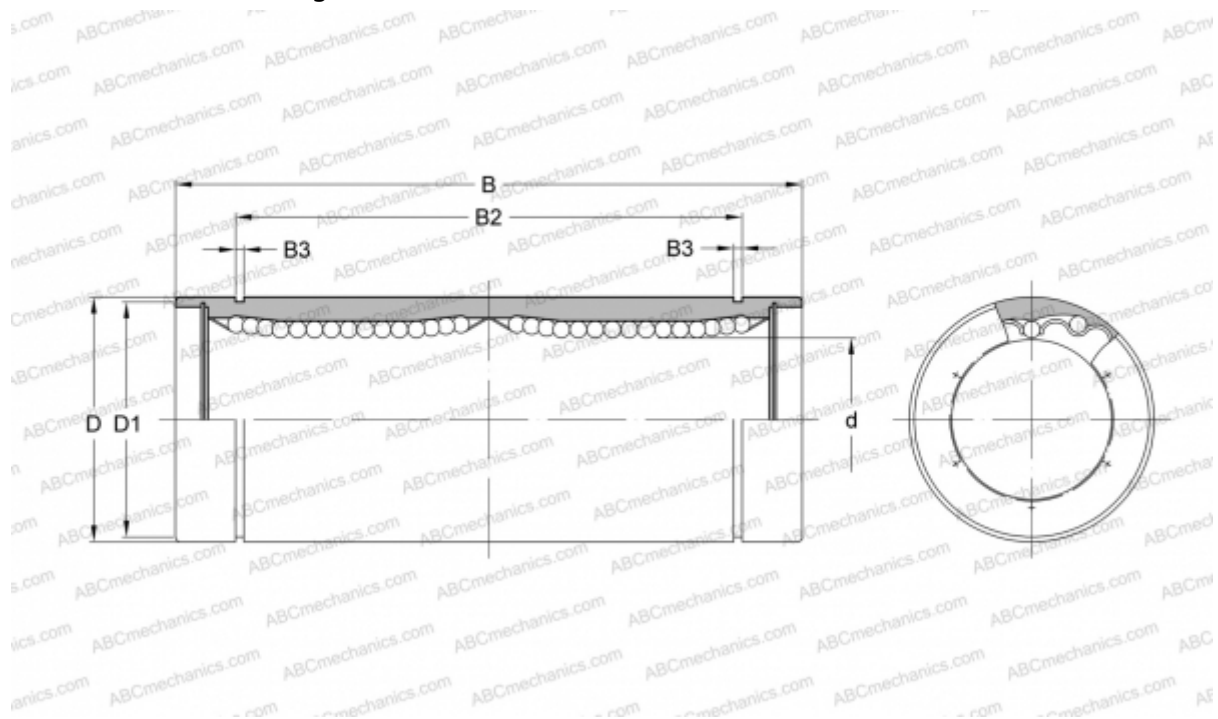

Technical specification

DIMENSIONS, MM

d	25,000
D	40,000
B	112,000
D1	38,000
B2	82,000
B3	1,850

WEIGHT, KG 0,440

MANUFACTURER [SAMICK](http://www.samick.com)