

LME50L UU SAMICK

Linear bushing

TYPE: Shaft guidance systems, Linear bushing, Standard, Close type, double length, Type LME..L, European standard, Plastic cage (SAMICK)

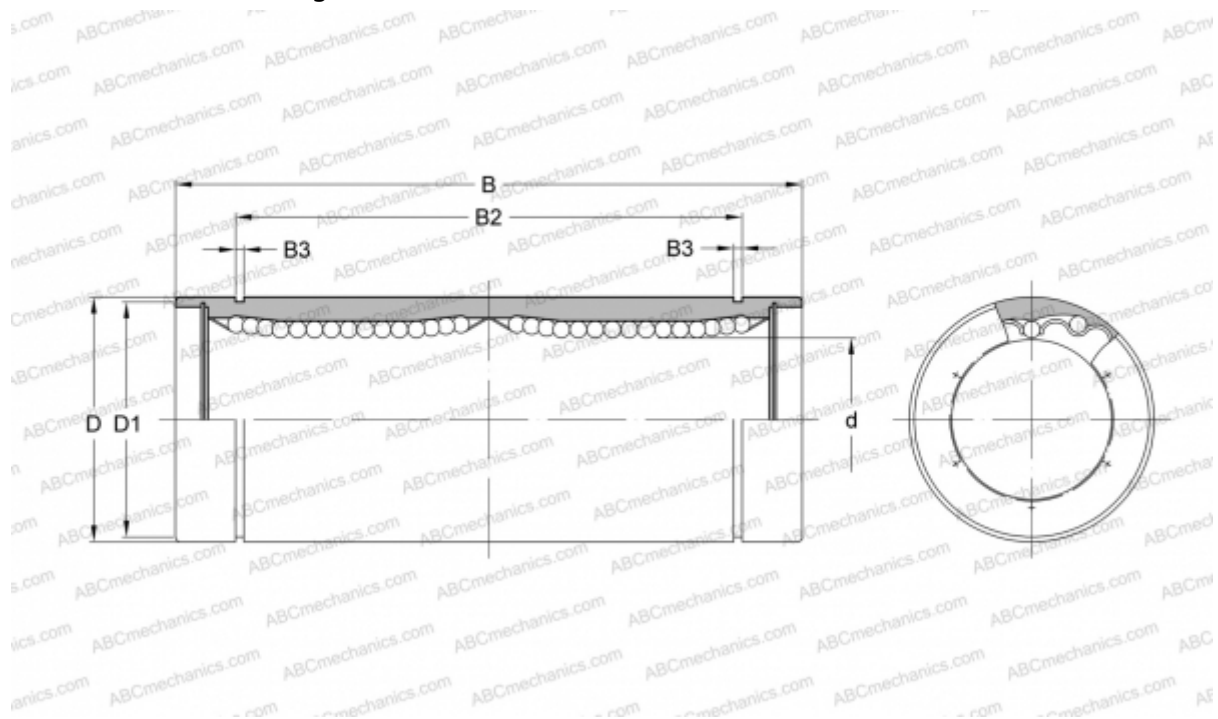

Technical specification

DIMENSIONS, MM

d	50,000
D	75,000
B	192,000
D1	72,000
B2	155,200
B3	2,650

WEIGHT, KG 3,100

MANUFACTURER [SAMICK](http://www.samick.com)