

LME8L UU A SAMICK

Linear bushing

TYPE: Shaft guidance systems, Linear bushing, Standard, Close type, double length, Type LME..L, European standard, Steel cage (SAMICK)

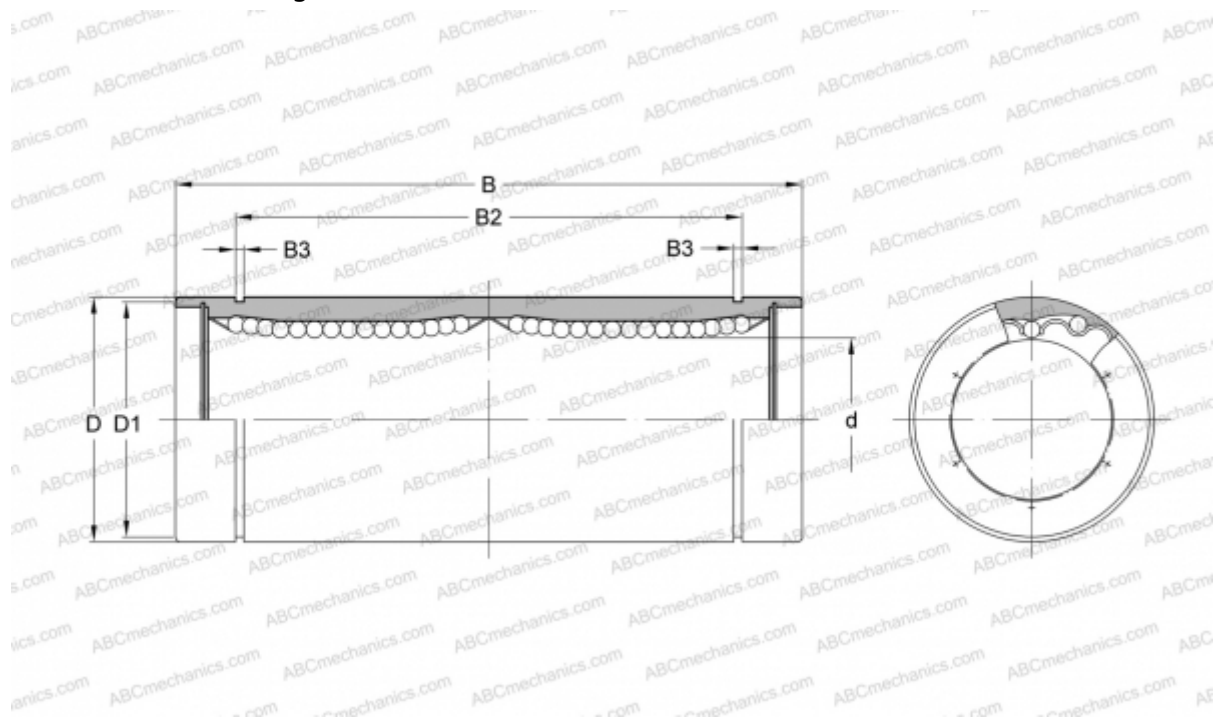

Technical specification

DIMENSIONS, MM

d	8,000
D	16,000
B	45,000
D1	15,200
B2	33,000
B3	1,100

WEIGHT, KG 0,031

MANUFACTURER [SAMICK](http://www.samick.com)