

LME12L UU A SAMICK

Linear bushing

TYPE: Shaft guidance systems, Linear bushing, Standard, Close type, double length, Type LME..L, European standard, Steel cage (SAMICK)

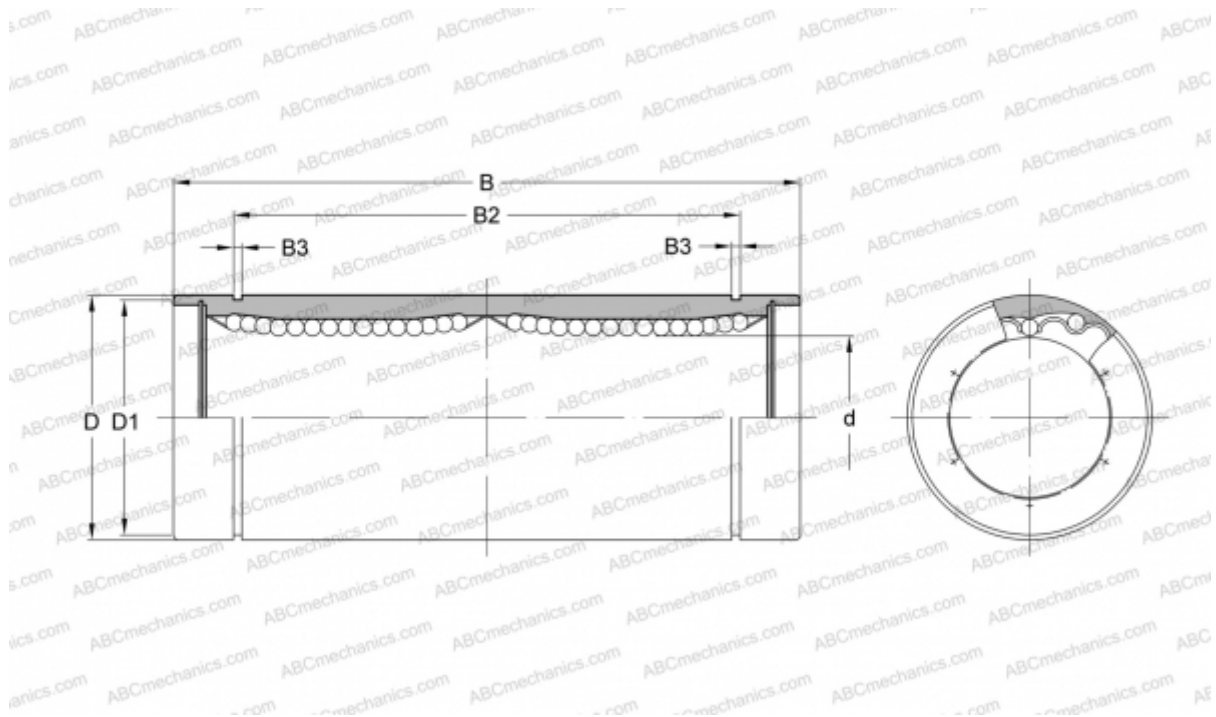

Technical specification

DIMENSIONS, MM

d	12,000
D	22,000
B	57,000
D1	21,000
B2	45,800
B3	1,300

WEIGHT, KG 0,080

MANUFACTURER [SAMICK](http://www.samick.com)