

LM8L UU SAMICK

Linear bushing

TYPE: Shaft guidance systems, Linear bushing, Standard, Close type, double length, Type LM..L, Asian standard, Plastic cage (SAMICK)

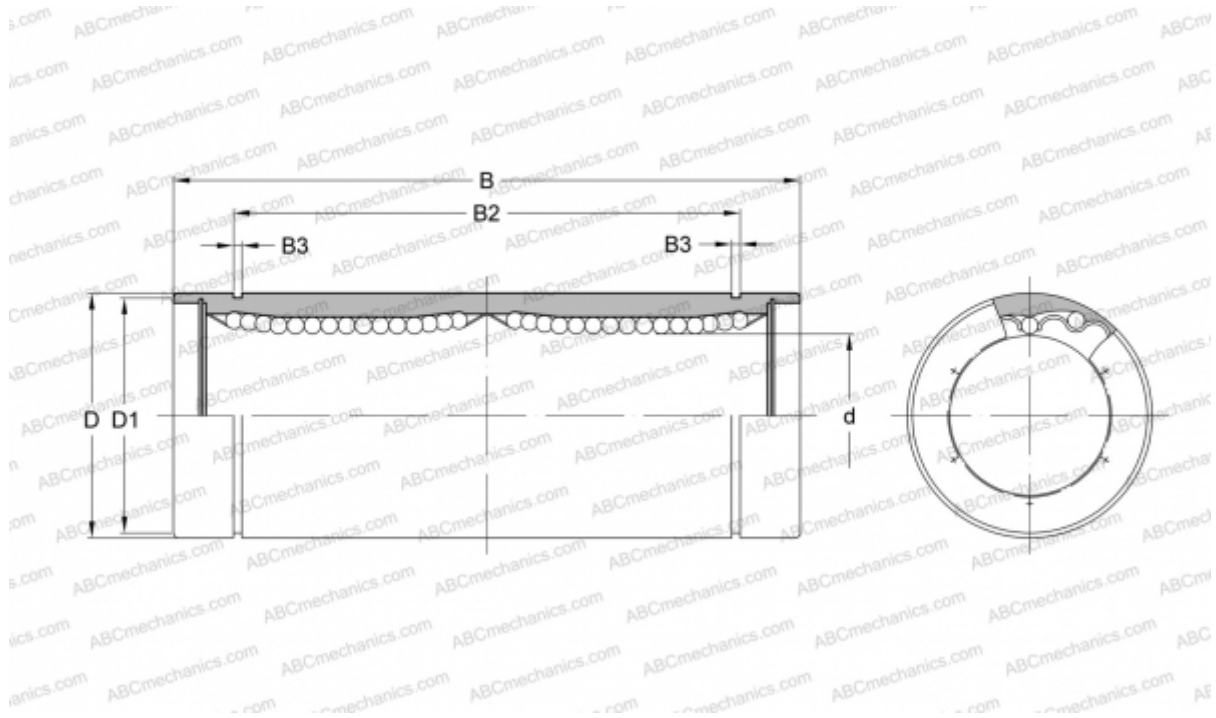

Technical specification

DIMENSIONS, MM

d	8,000
D	15,000
B	45,000
D1	14,300
B2	35,000
B3	1,100

WEIGHT, KG 0,031

MANUFACTURER [SAMICK](http://www.samick.com)