

LM10L UU SAMICK

Linear bushing

TYPE: Shaft guidance systems, Linear bushing, Standard, Close type, double length, Type LM..L, Asian standard, Plastic cage (SAMICK)

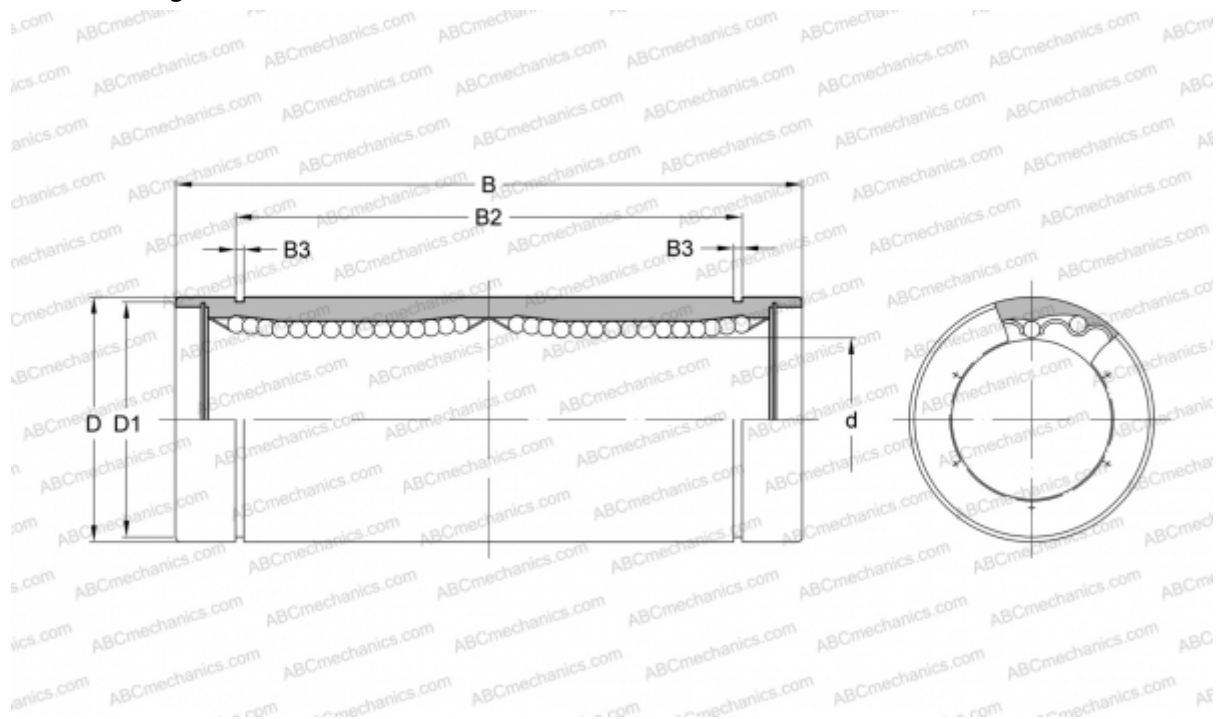

Technical specification

DIMENSIONS, MM

d	10,000
D	19,000
B	55,000
D1	18,000
B2	44,000
B3	1,300

WEIGHT, KG 0,062

MANUFACTURER [SAMICK](http://www.samick.com)