

LM13L UU SAMICK

Linear bushing

TYPE: Shaft guidance systems, Linear bushing, Standard, Close type, double length, Type LM..L, Asian standard, Plastic cage (SAMICK)

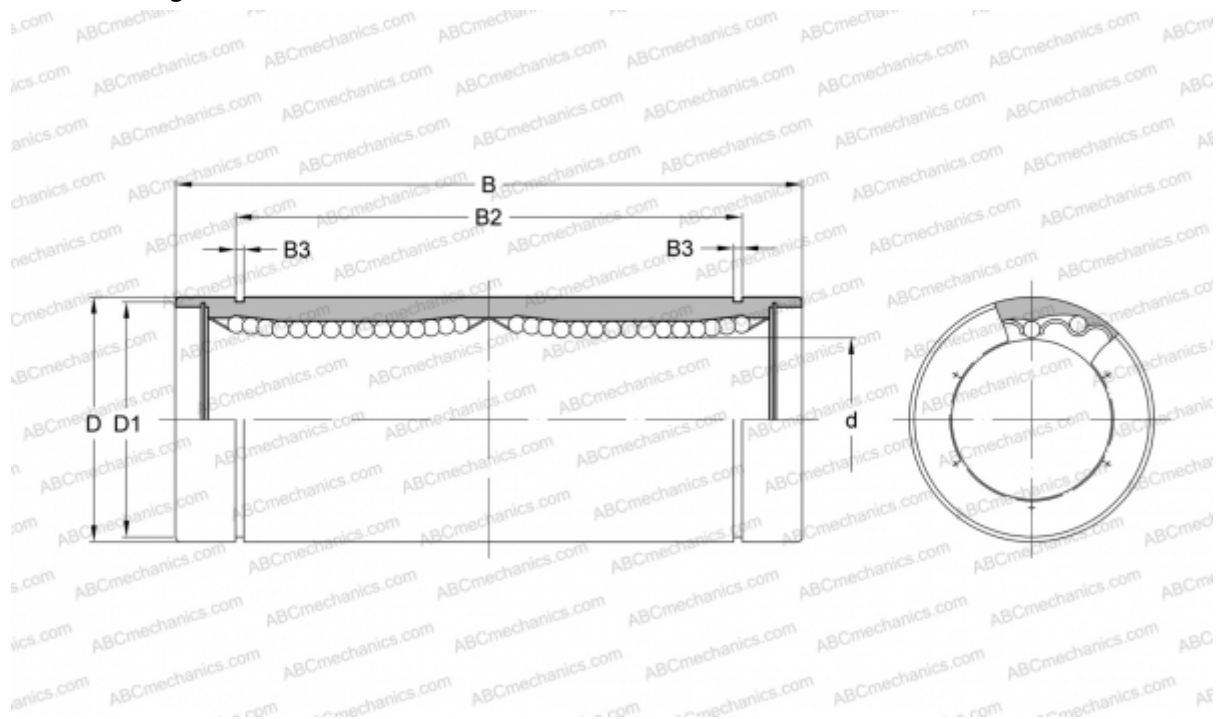

Technical specification

DIMENSIONS, MM

d	13,000
D	23,000
B	61,000
D1	22,000
B2	46,000
B3	1,300

WEIGHT, KG 0,090

MANUFACTURER [SAMICK](http://www.samick.com)