

LM20L UU SAMICK

Linear bushing

TYPE: Shaft guidance systems, Linear bushing, Standard, Close type, double length, Type LM..L, Asian standard, Plastic cage (SAMICK)

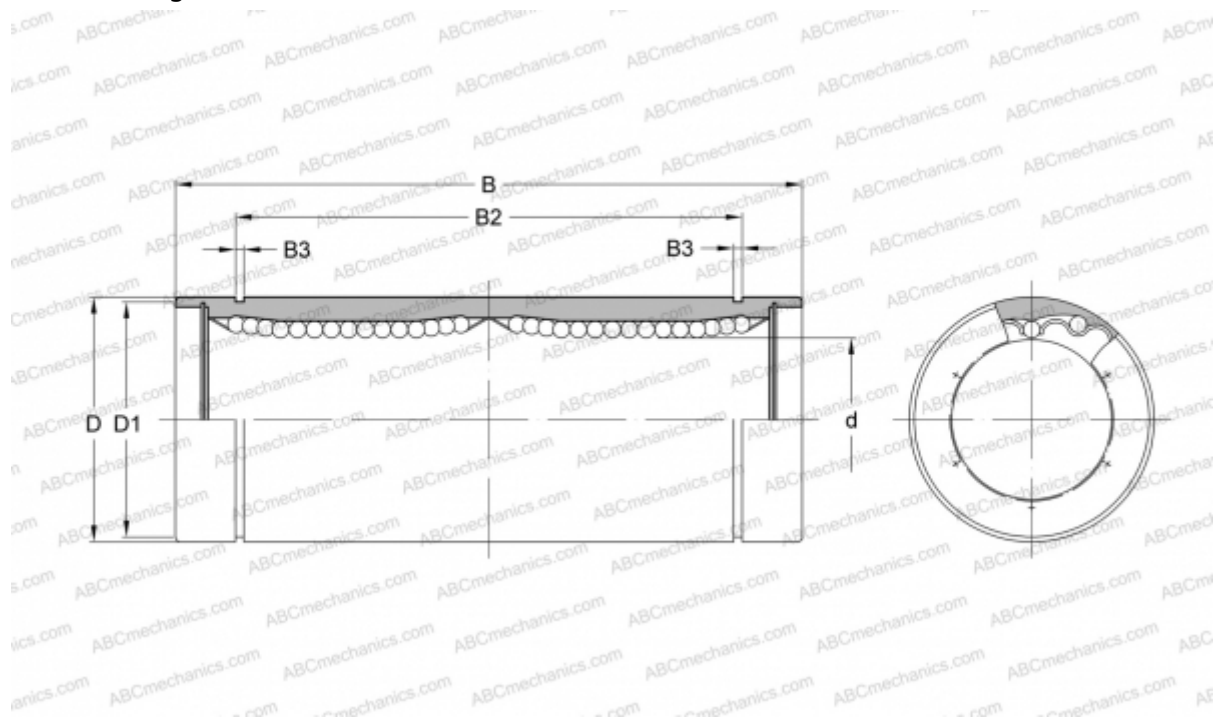

Technical specification

DIMENSIONS, MM

d	20,000
D	32,000
B	80,000
D1	30,500
B2	61,000
B3	1,600

WEIGHT, KG 0,180

MANUFACTURER [SAMICK](http://www.samick.com)