

## LM25L UU SAMICK

Linear bushing

TYPE: Shaft guidance systems, Linear bushing, Standard, Close type, double length, Type LM..L, Asian standard, Plastic cage (SAMICK)

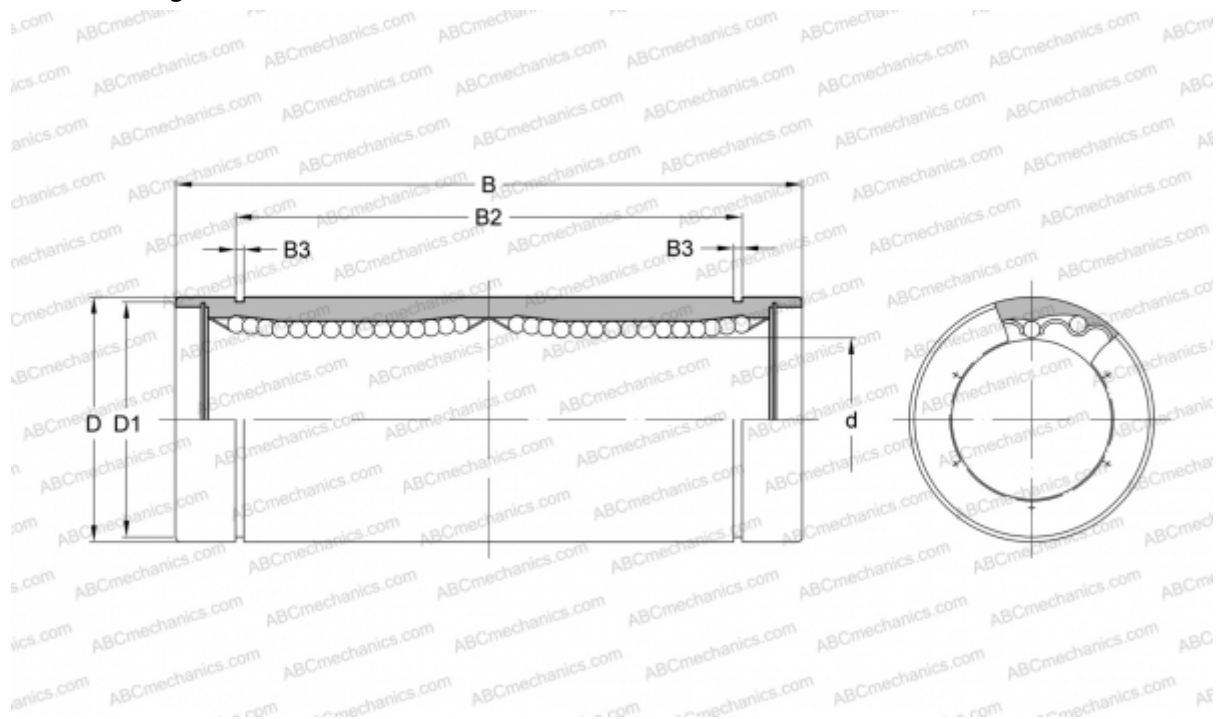

### Technical specification

#### DIMENSIONS, MM

d	25,000
D	40,000
B	112,000
D1	38,000
B2	82,000
B3	1,850

**WEIGHT, KG** 0,440

**MANUFACTURER** [SAMICK](http://www.samick.com)