

## LM30L UU SAMICK

Linear bushing

TYPE: Shaft guidance systems, Linear bushing, Standard, Close type, double length, Type LM..L, Asian standard, Plastic cage (SAMICK)

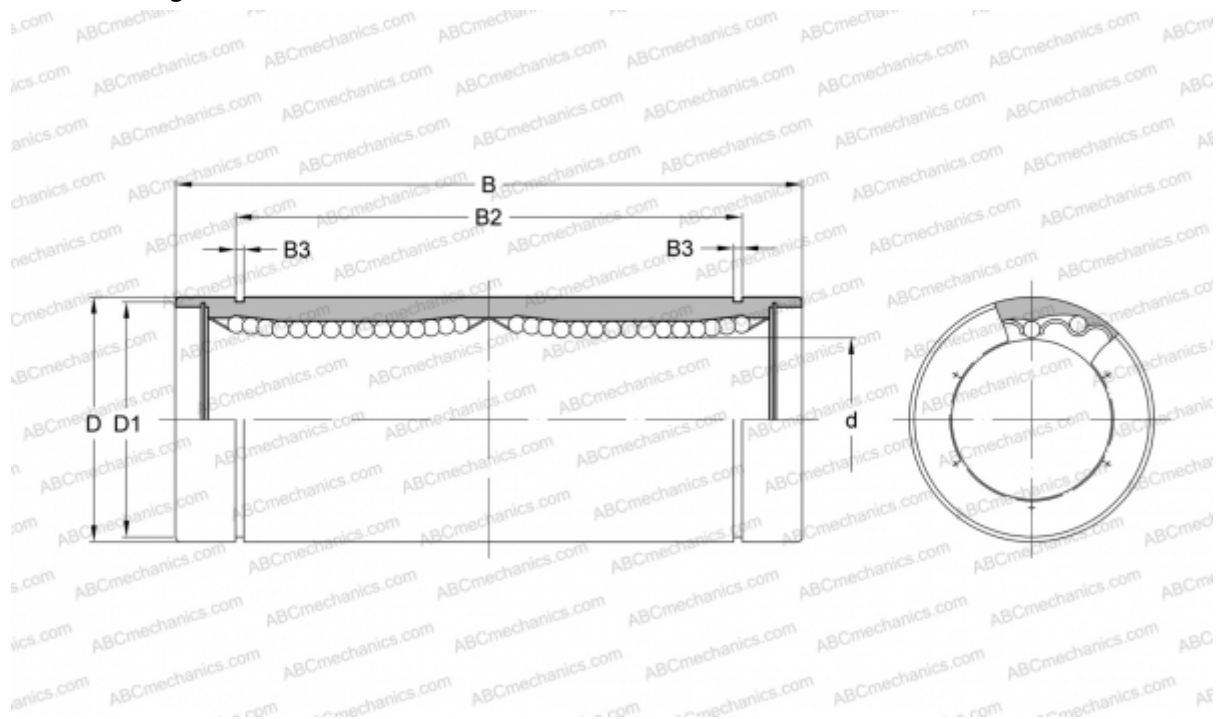

### Technical specification

#### DIMENSIONS, MM

d	30,000
D	45,000
B	123,000
D1	43,000
B2	89,000
B3	1,850

**WEIGHT, KG** 0,580

**MANUFACTURER** [SAMICK](http://www.samick.com)