

LM35L UU SAMICK

Linear bushing

TYPE: Shaft guidance systems, Linear bushing, Standard, Close type, double length, Type LM..L, Asian standard, Plastic cage (SAMICK)

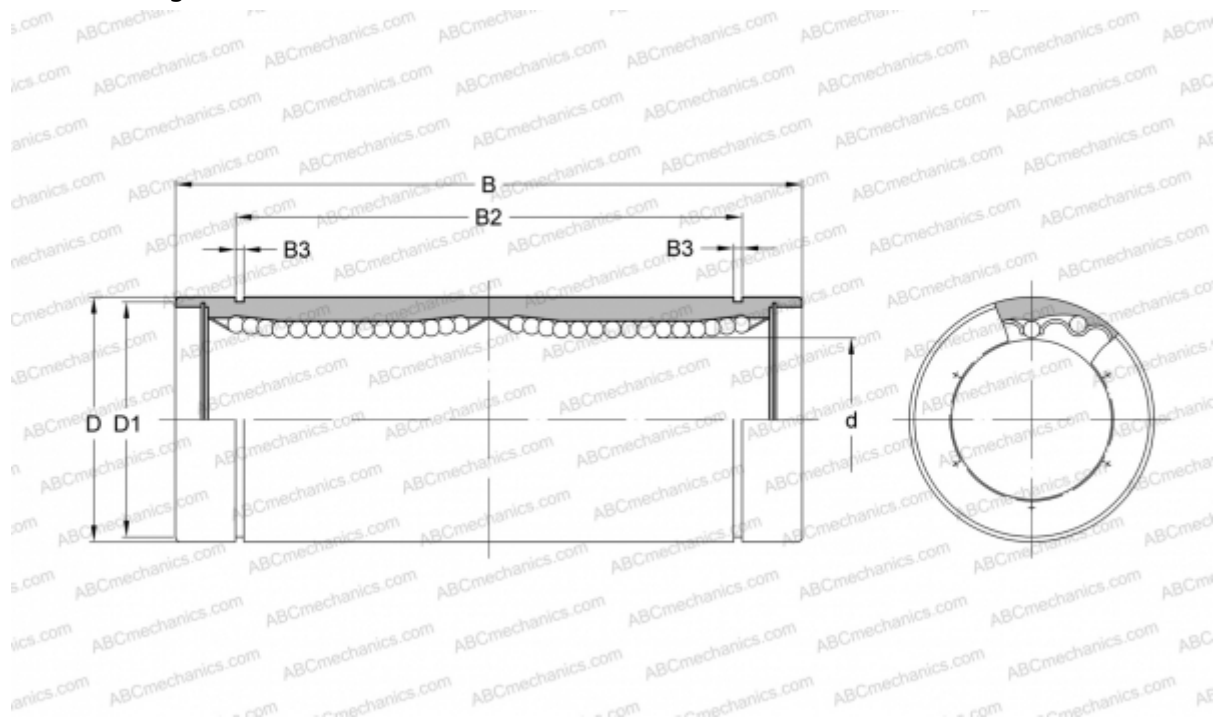

Technical specification

DIMENSIONS, MM

d	35,000
D	52,000
B	135,000
D1	49,000
B2	99,000
B3	2,100

WEIGHT, KG 0,795

MANUFACTURER [SAMICK](http://www.samick.com)