

## LM60L UU SAMICK

Linear bushing

TYPE: Shaft guidance systems, Linear bushing, Standard, Close type, double length, Type LM..L, Asian standard, Plastic cage (SAMICK)

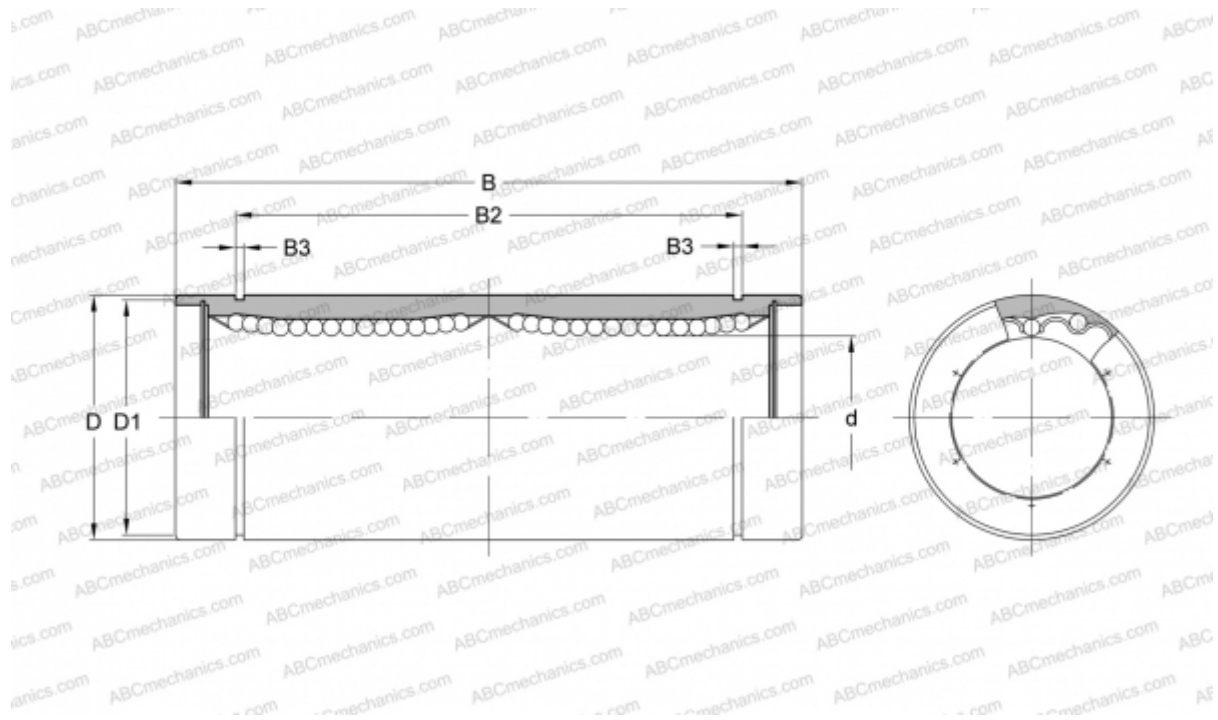

### Technical specification

#### DIMENSIONS, MM

d	60,000
D	90,000
B	211,000
D1	86,500
B2	170,000
B3	3,150

**WEIGHT, KG** 3,500

**MANUFACTURER** [SAMICK](http://www.samick.com)