

LME20 UU AJ SAMICK

Linear bushing

TYPE: Shaft guidance systems, Linear bushing, Standard, Adjustable type, Type LME..AJ, European standard, Plastic cage (SAMICK)

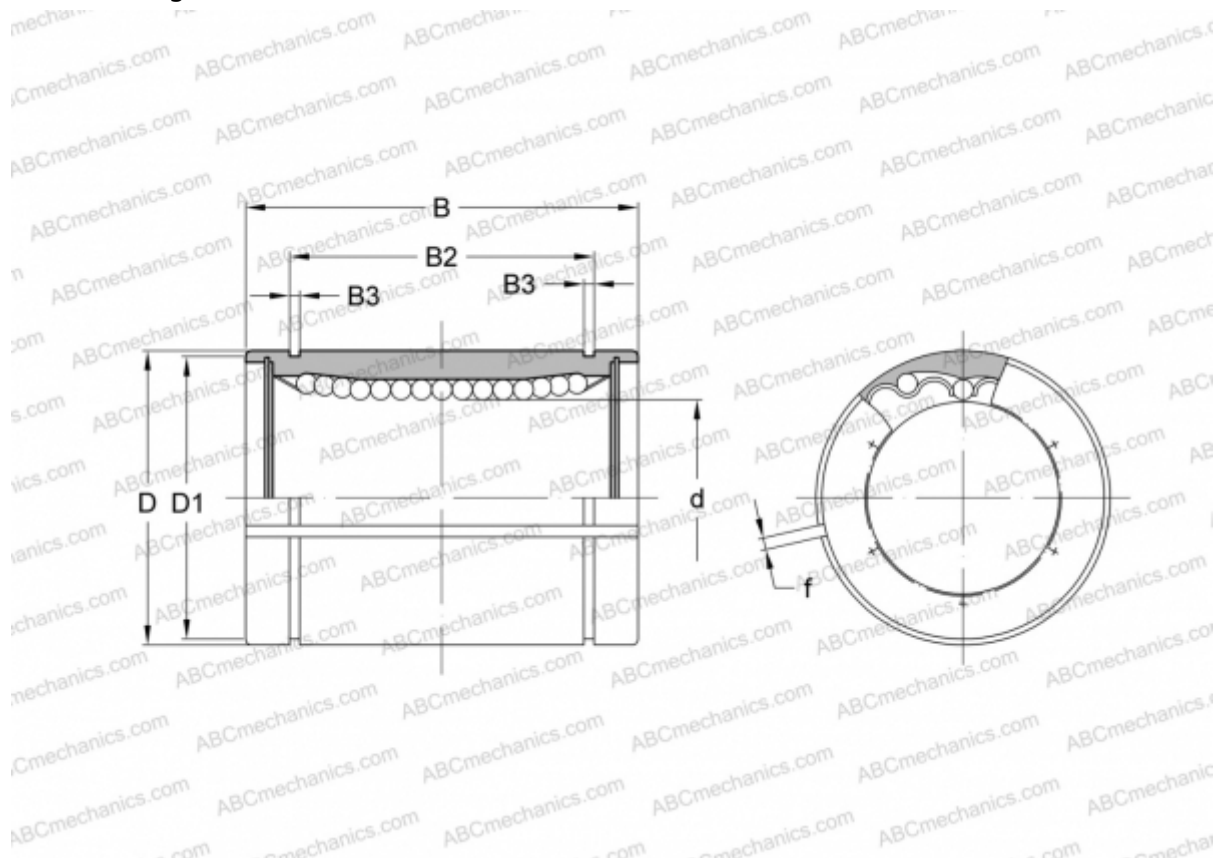

Technical specification

DIMENSIONS, MM

d	20,000
D	32,000
B	45,000
D1	30,300
B2	31,500
B3	1,600
f	2,000

WEIGHT, KG 0,091

MANUFACTURER [SAMICK](http://www.samick.com)