

## LME30 UU AJ SAMICK

Linear bushing

TYPE: Shaft guidance systems, Linear bushing, Standard, Adjustable type, Type LME..AJ, European standard, Plastic cage (SAMICK)

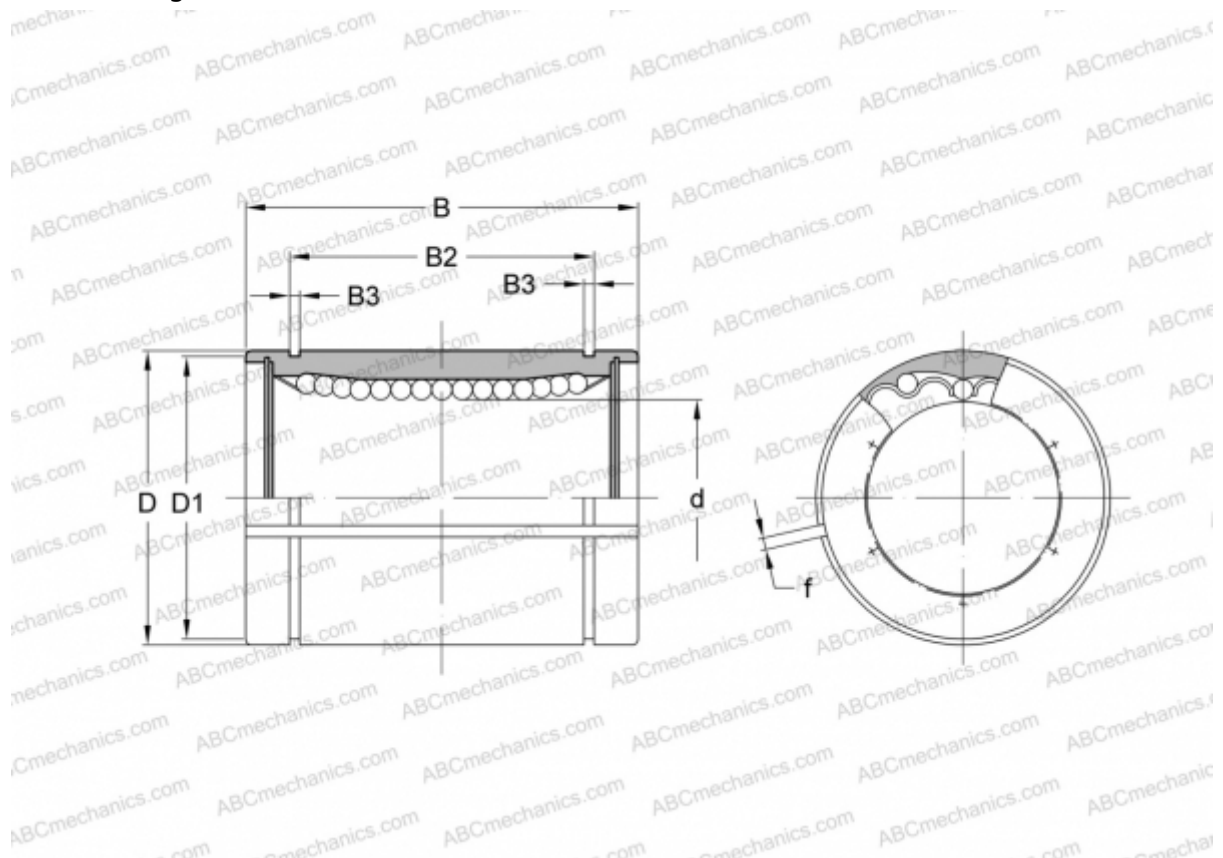

### Technical specification

#### DIMENSIONS, MM

d	30,000
D	47,000
B	68,000
D1	44,500
B2	52,100
B3	1,850
f	2,000

**WEIGHT, KG** 0,325

**MANUFACTURER** [SAMICK](http://www.samick.com)