

## LME40 UU AJ SAMICK

Linear bushing

TYPE: Shaft guidance systems, Linear bushing, Standard, Adjustable type, Type LME..AJ, European standard, Plastic cage (SAMICK)

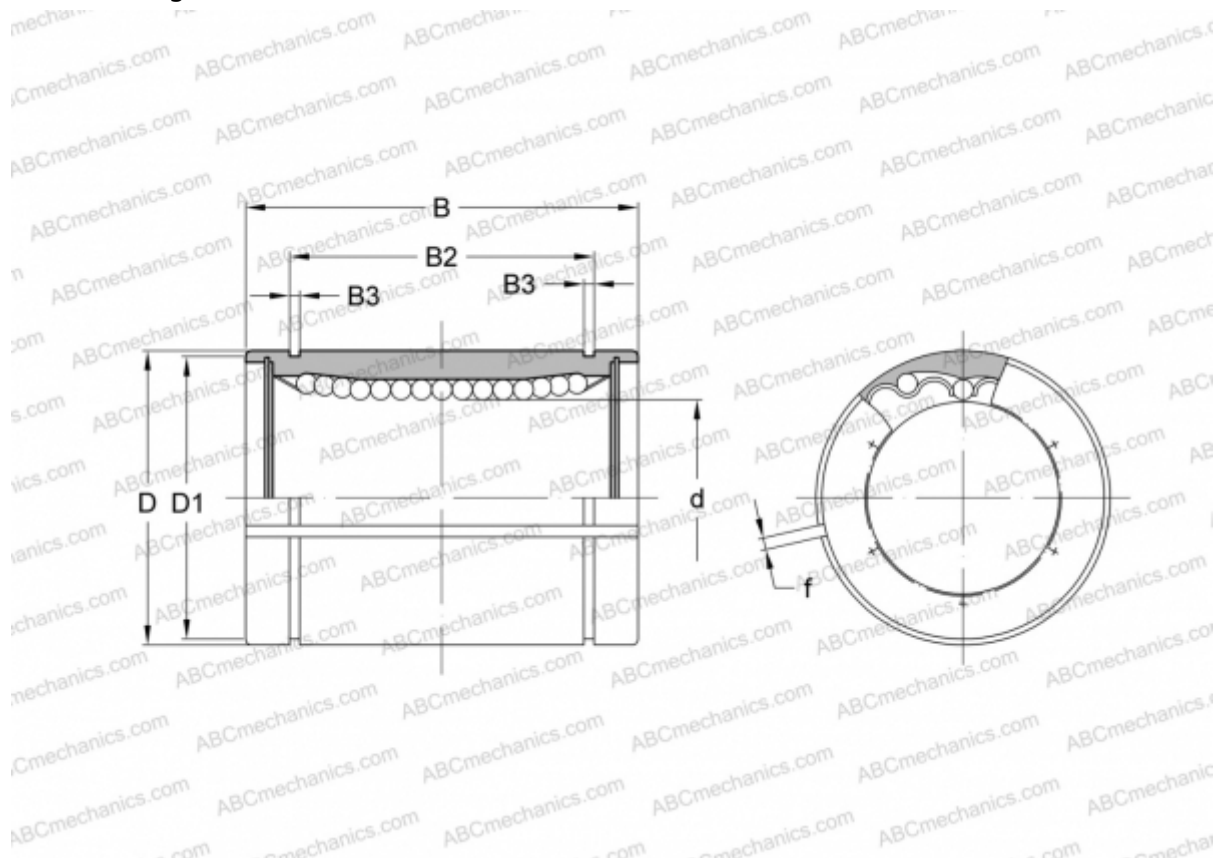

### Technical specification

#### DIMENSIONS, MM

d	40,000
D	62,000
B	80,000
D1	59,000
B2	60,600
B3	2,150
f	3,000

**WEIGHT, KG** 0,705

**MANUFACTURER** [SAMICK](http://www.samick.com)