

## LME50 UU AJ SAMICK

Linear bushing

TYPE: Shaft guidance systems, Linear bushing, Standard, Adjustable type, Type LME..AJ, European standard, Plastic cage (SAMICK)

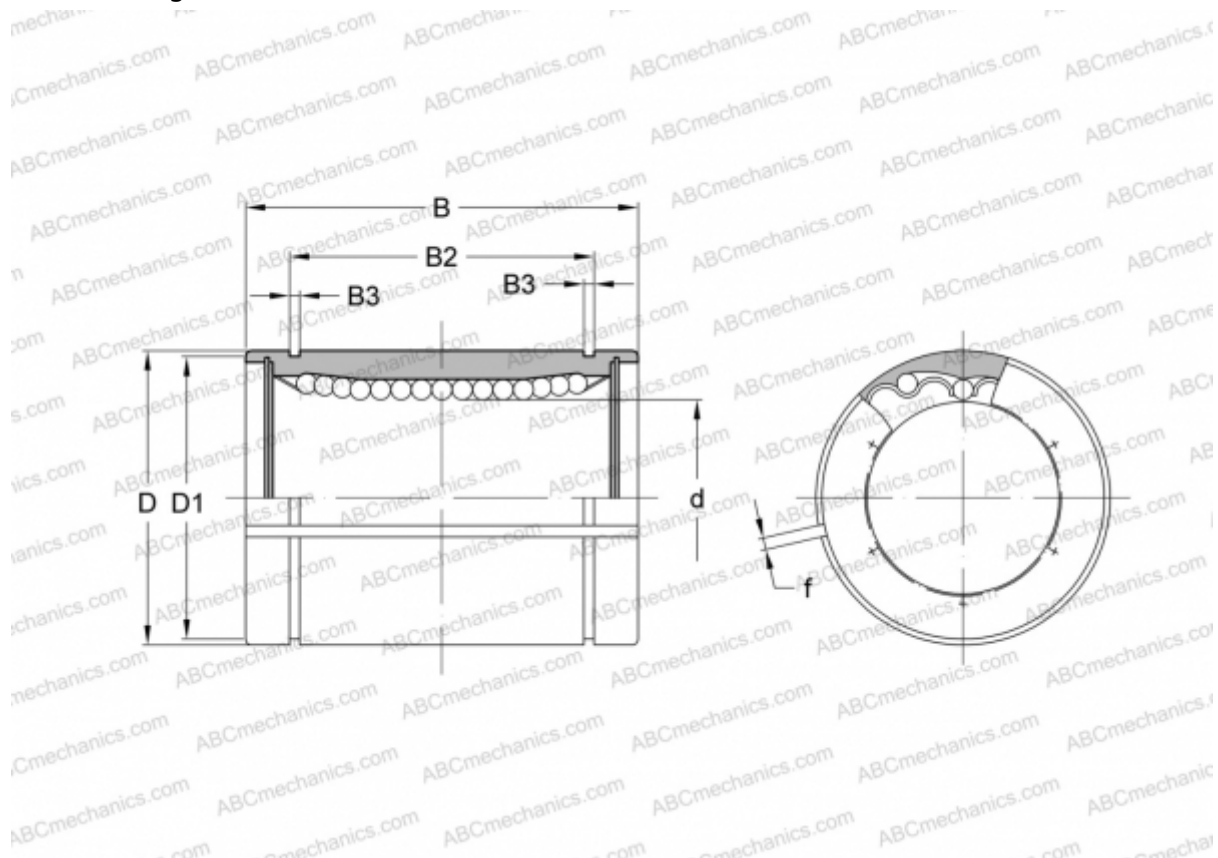

### Technical specification

#### DIMENSIONS, MM

d	50,000
D	75,000
B	100,000
D1	72,000
B2	77,600
B3	2,650
f	3,000

**WEIGHT, KG** 1,130

**MANUFACTURER** [SAMICK](http://www.samick.com)