

## LME8 UU AJ A SAMICK

Linear bushing

TYPE: Shaft guidance systems, Linear bushing, Standard, Adjustable type, Type LME..AJ, European standard, Steel cage (SAMICK)

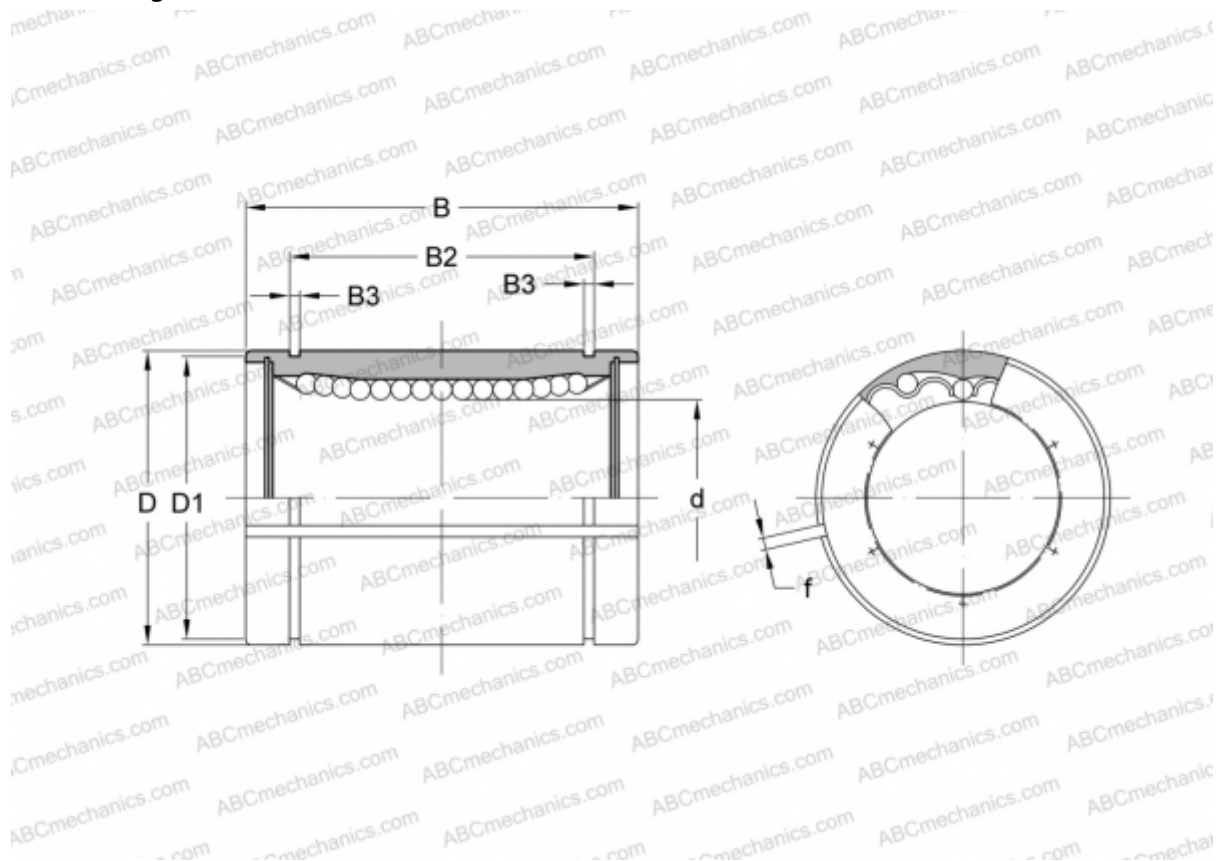

### Technical specification

#### DIMENSIONS, MM

d	8,000
D	16,000
B	25,000
D1	15,200
B2	16,500
B3	1,100
f	1,000

**WEIGHT, KG** 0,020

**MANUFACTURER** [SAMICK](http://www.samick.com)