

## LME20 UU AJ A SAMICK

Linear bushing

TYPE: Shaft guidance systems, Linear bushing, Standard, Adjustable type, Type LME..AJ, European standard, Steel cage (SAMICK)

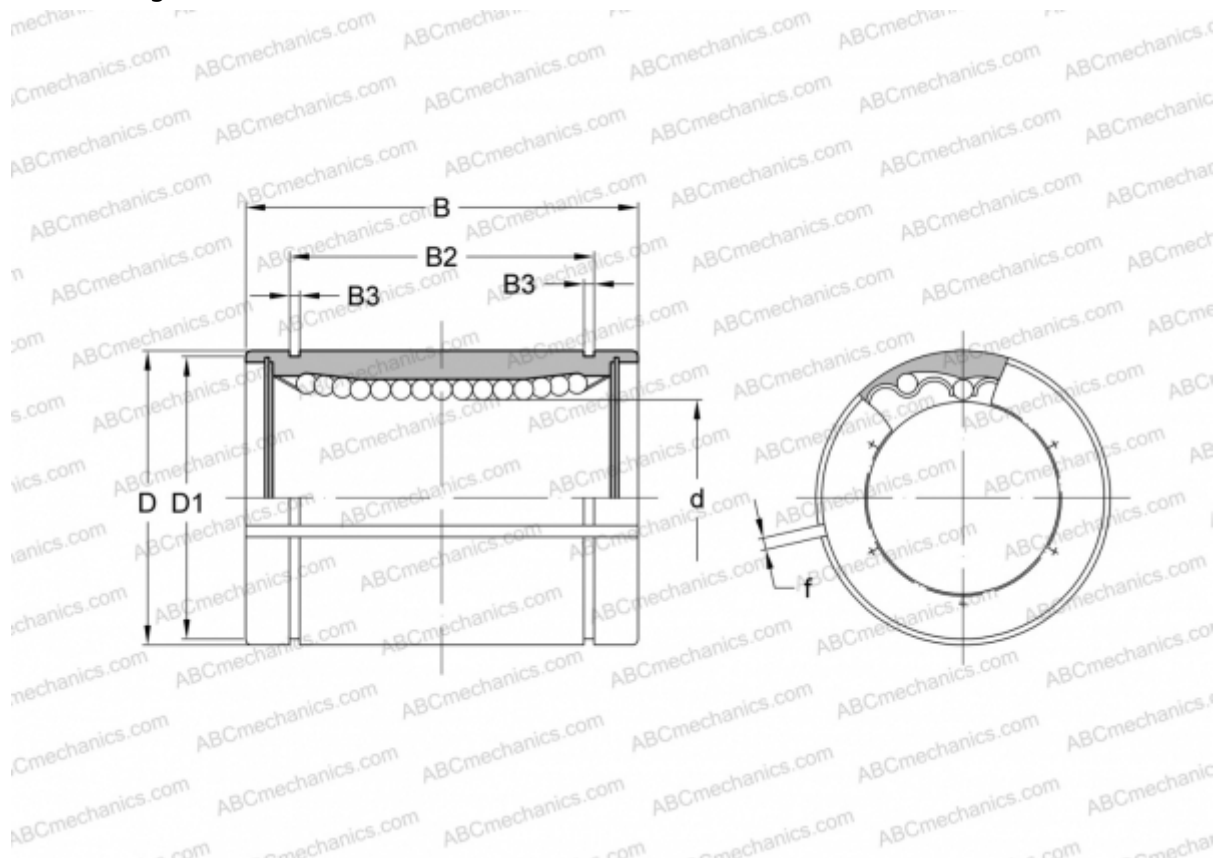

### Technical specification

#### DIMENSIONS, MM

d	20,000
D	32,000
B	45,000
D1	30,300
B2	31,500
B3	1,600
f	2,000

**WEIGHT, KG** 0,091

**MANUFACTURER** [SAMICK](http://www.samick.com)