

## LM6 UU AJ SAMICK

Linear bushing

TYPE: Shaft guidance systems, Linear bushing, Standard, Adjustable type, Type LM..AJ, Asian standard, Plastic cage (SAMICK)

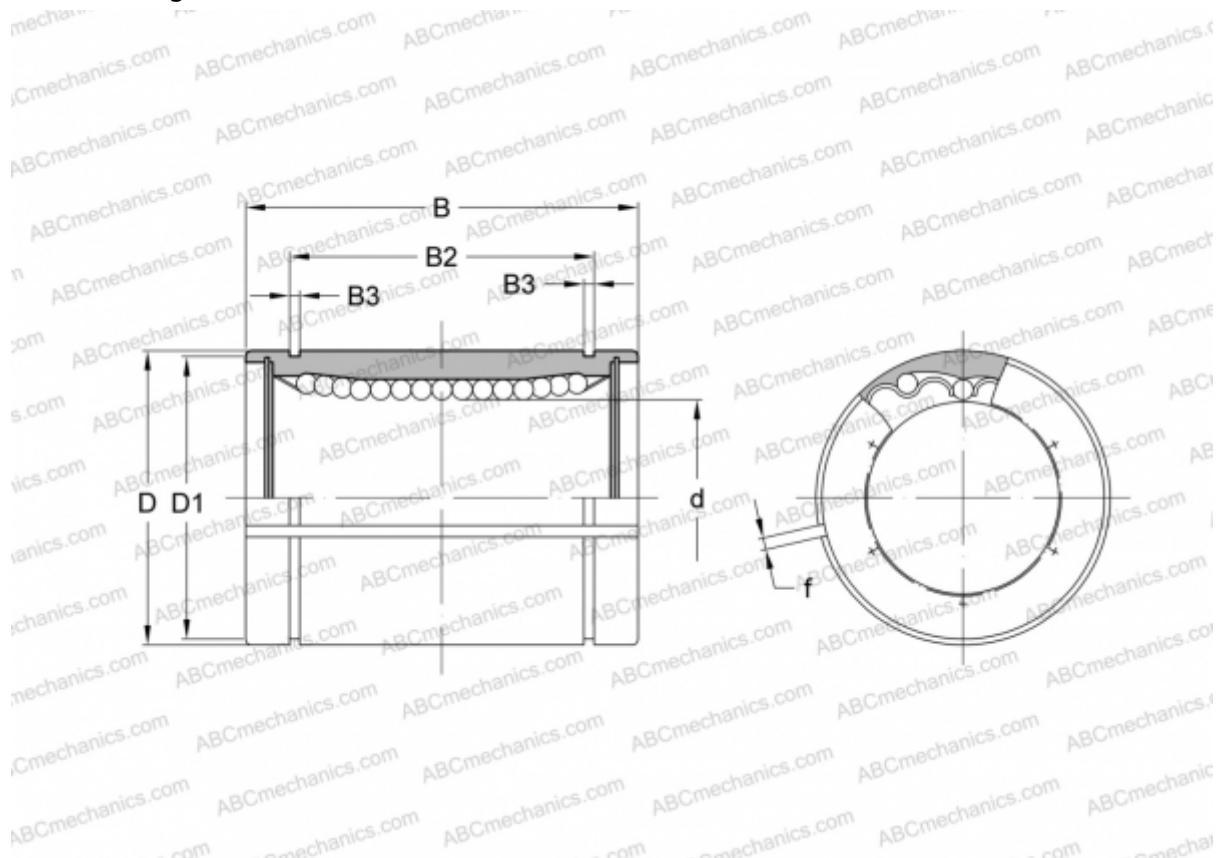

### Technical specification

#### DIMENSIONS, MM

d	6,000
D	12,000
B	19,000
D1	11,500
B2	13,500
B3	1,100
f	1,000

**WEIGHT, KG** 0,008

**MANUFACTURER** [SAMICK](http://www.samick.com)