

LM8 UU AJ SAMICK

Linear bushing

TYPE: Shaft guidance systems, Linear bushing, Standard, Adjustable type, Type LM..AJ, Asian standard, Plastic cage (SAMICK)

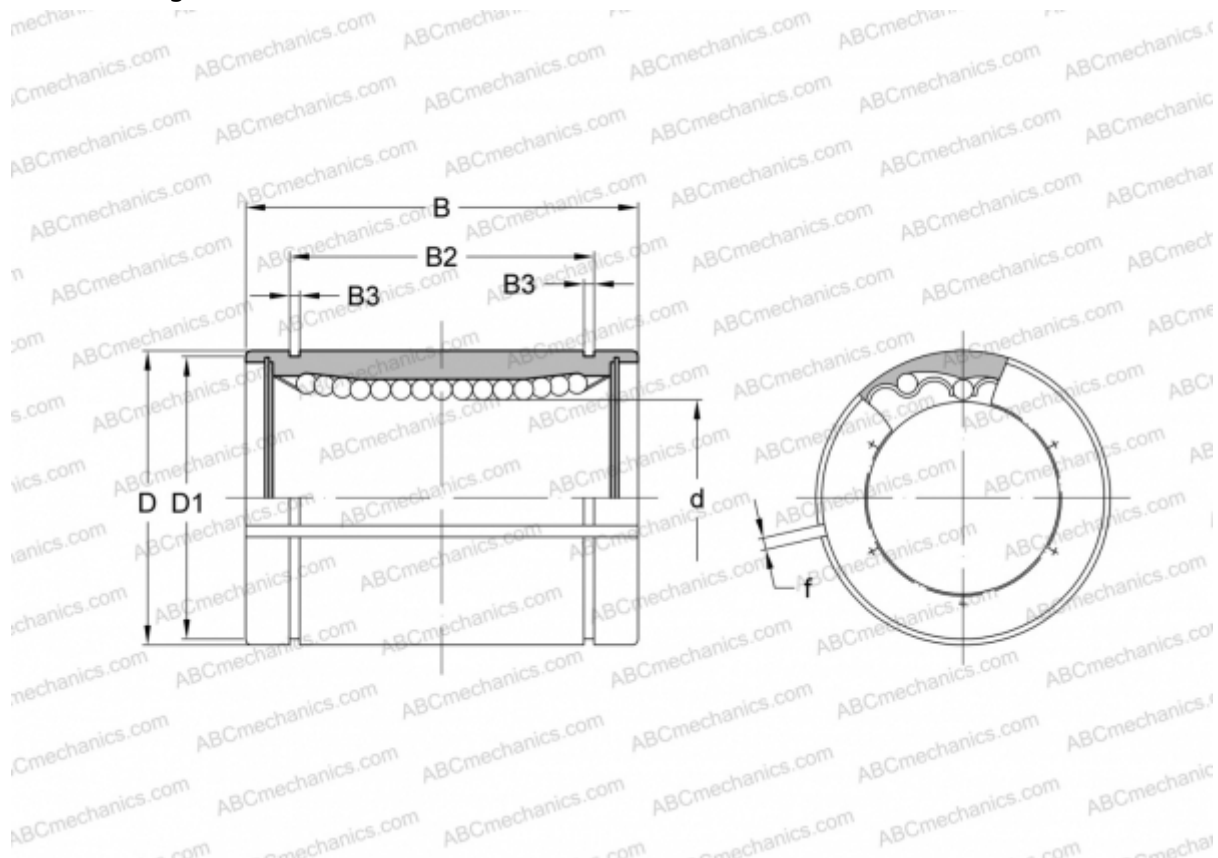

Technical specification

DIMENSIONS, MM

d	8,000
D	15,000
B	24,000
D1	14,300
B2	17,500
B3	1,100
f	1,000

WEIGHT, KG 0,016

MANUFACTURER [SAMICK](http://www.samick.com)