

## LM13 UU AJ SAMICK

Linear bushing

TYPE: Shaft guidance systems, Linear bushing, Standard, Adjustable type, Type LM..AJ, Asian standard, Plastic cage (SAMICK)

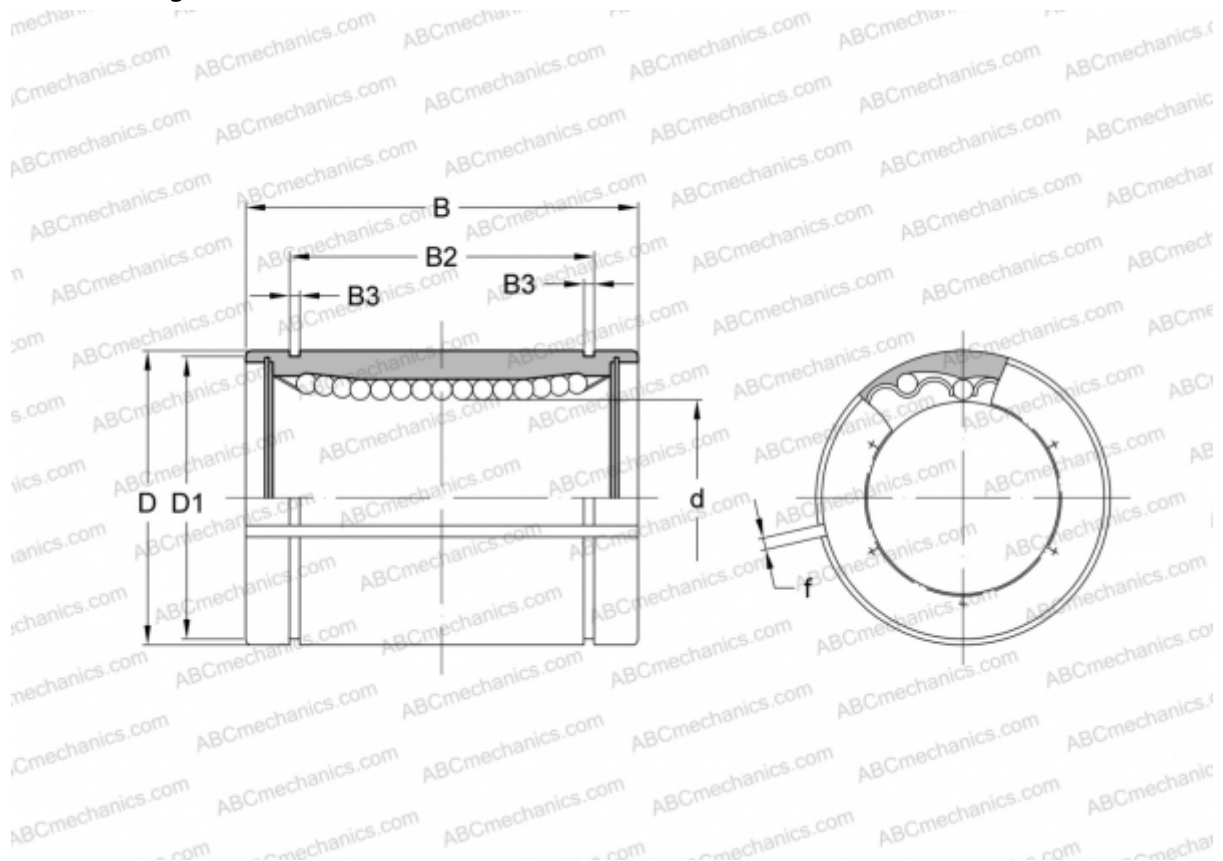

### Technical specification

#### DIMENSIONS, MM

d	13,000
D	23,000
B	32,000
D1	22,000
B2	23,000
B3	1,300
f	1,500

**WEIGHT, KG** 0,043

**MANUFACTURER** [SAMICK](http://www.samick.com)