

LM16 UU AJ SAMICK

Linear bushing

TYPE: Shaft guidance systems, Linear bushing, Standard, Adjustable type, Type LM..AJ, Asian standard, Plastic cage (SAMICK)

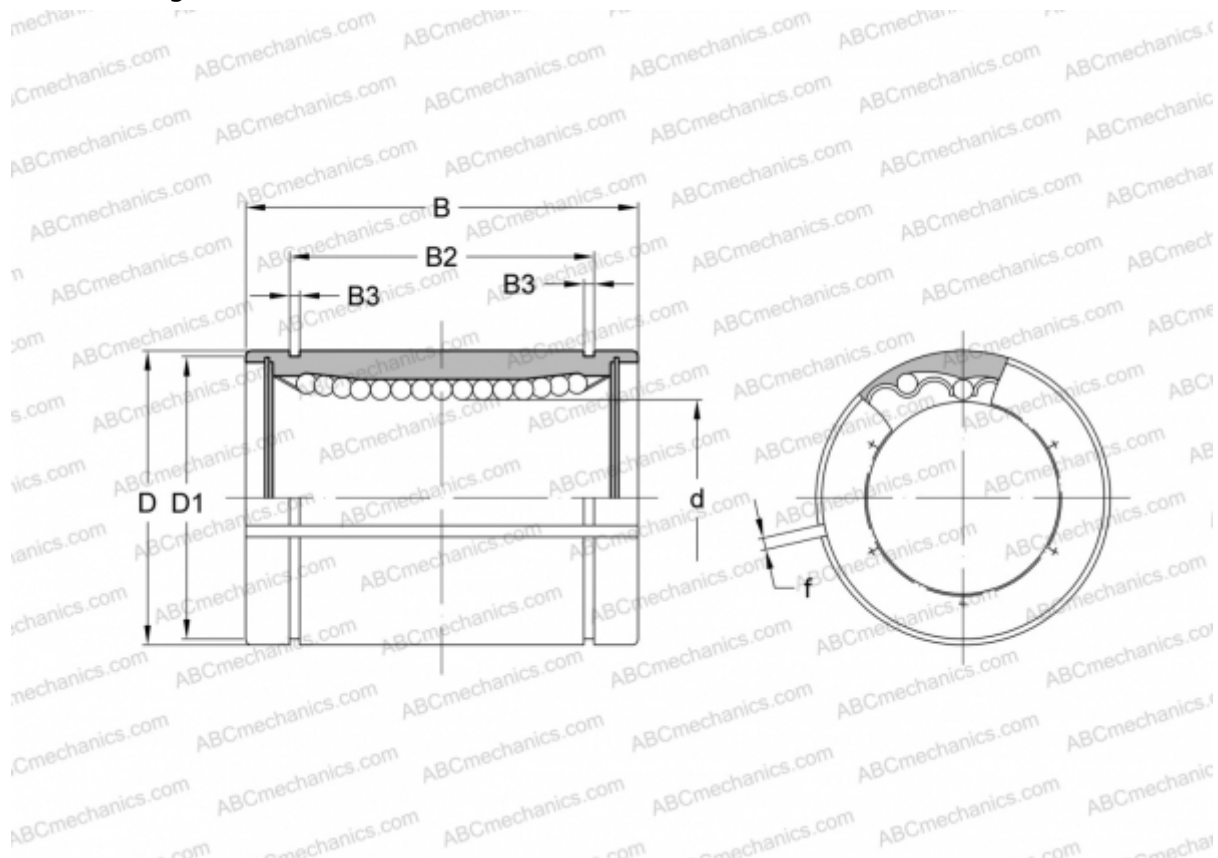

Technical specification

DIMENSIONS, MM

d	16,000
D	28,000
B	37,000
D1	27,000
B2	26,500
B3	1,600
f	1,500

WEIGHT, KG 0,069

MANUFACTURER [SAMICK](http://www.samick.com)