

LM20 UU AJ SAMICK

Linear bushing

TYPE: Shaft guidance systems, Linear bushing, Standard, Adjustable type, Type LM..AJ, Asian standard, Plastic cage (SAMICK)

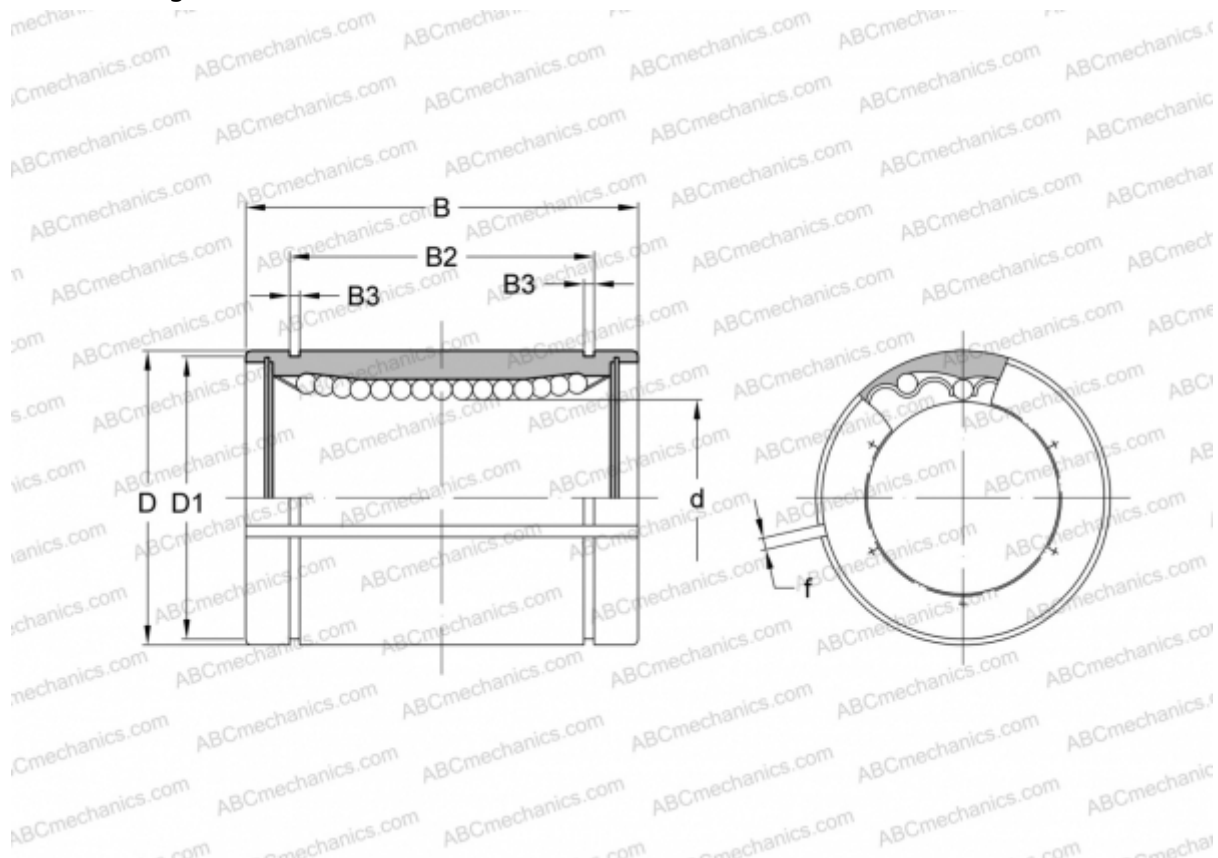

Technical specification

DIMENSIONS, MM

d	20,000
D	32,000
B	42,000
D1	30,500
B2	30,500
B3	1,600
f	1,500

WEIGHT, KG 0,087

MANUFACTURER [SAMICK](http://www.samick.com)