

LM25 UU AJ SAMICK

Linear bushing

TYPE: Shaft guidance systems, Linear bushing, Standard, Adjustable type, Type LM..AJ, Asian standard, Plastic cage (SAMICK)

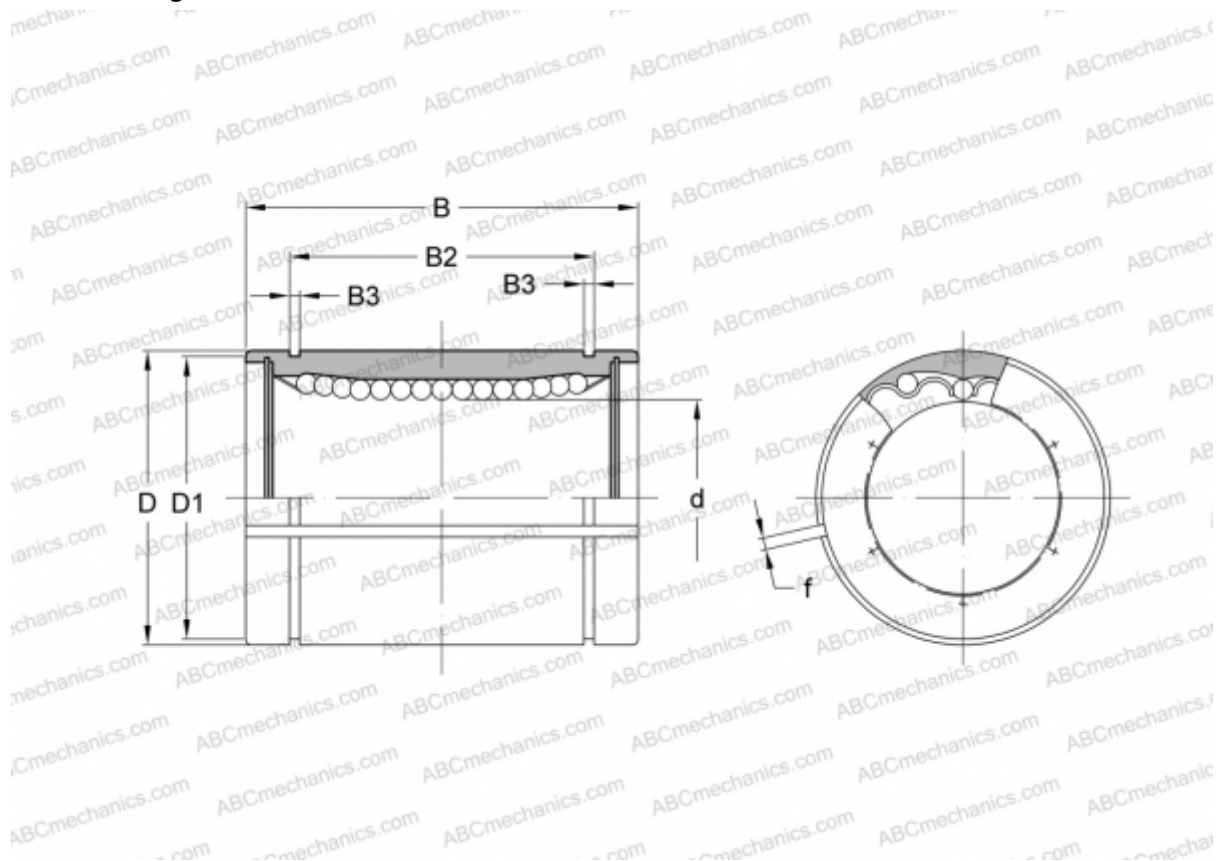

Technical specification

DIMENSIONS, MM

d	25,000
D	40,000
B	59,000
D1	38,000
B2	41,000
B3	1,850
f	2,000

WEIGHT, KG 0,220

MANUFACTURER [SAMICK](http://www.samick.com)