

LM30 UU AJ SAMICK

Linear bushing

TYPE: Shaft guidance systems, Linear bushing, Standard, Adjustable type, Type LM..AJ, Asian standard, Plastic cage (SAMICK)

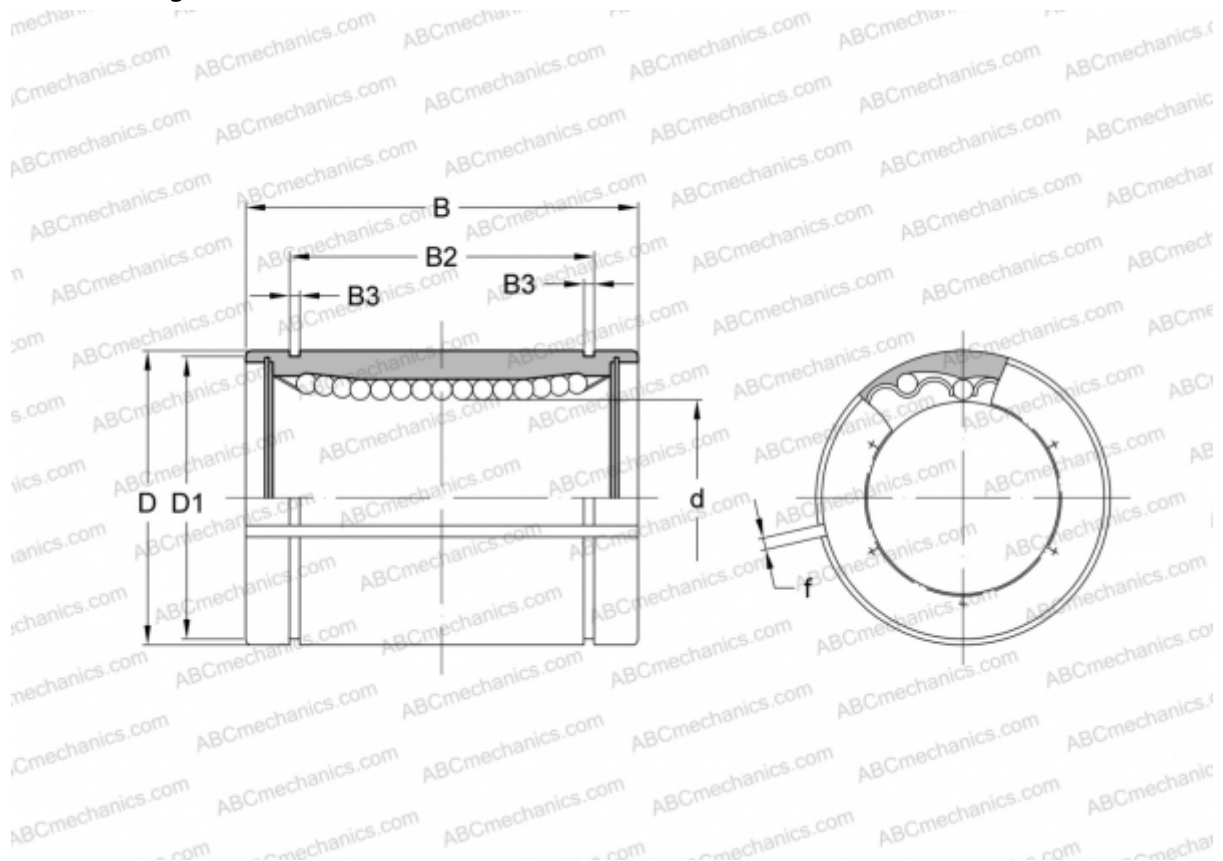

Technical specification

DIMENSIONS, MM

d	30,000
D	45,000
B	64,000
D1	43,000
B2	44,500
B3	1,850
f	2,500

WEIGHT, KG 0,250

MANUFACTURER [SAMICK](http://www.samick.com)