

LM35 UU AJ SAMICK

Linear bushing

TYPE: Shaft guidance systems, Linear bushing, Standard, Adjustable type, Type LM..AJ, Asian standard, Plastic cage (SAMICK)

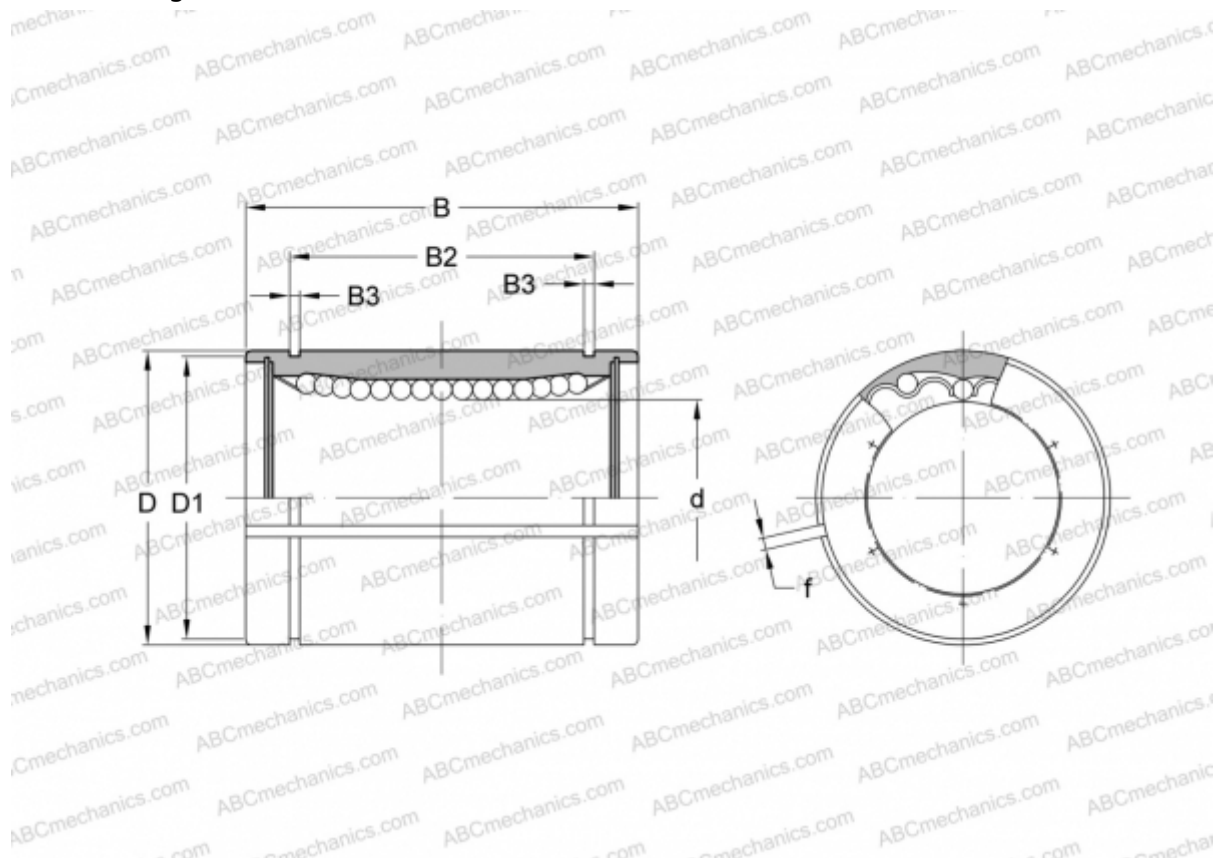

Technical specification

DIMENSIONS, MM

d	35,000
D	52,000
B	70,000
D1	49,000
B2	49,500
B3	2,100
f	2,500

WEIGHT, KG 0,390

MANUFACTURER [SAMICK](http://www.samick.com)