

LME12 UU OP A SAMICK

Linear bushing

TYPE: Shaft guidance systems, Linear bushing, Standard, Open type for support rail, Type LME..OP, European standard, Steel cage (SAMICK)

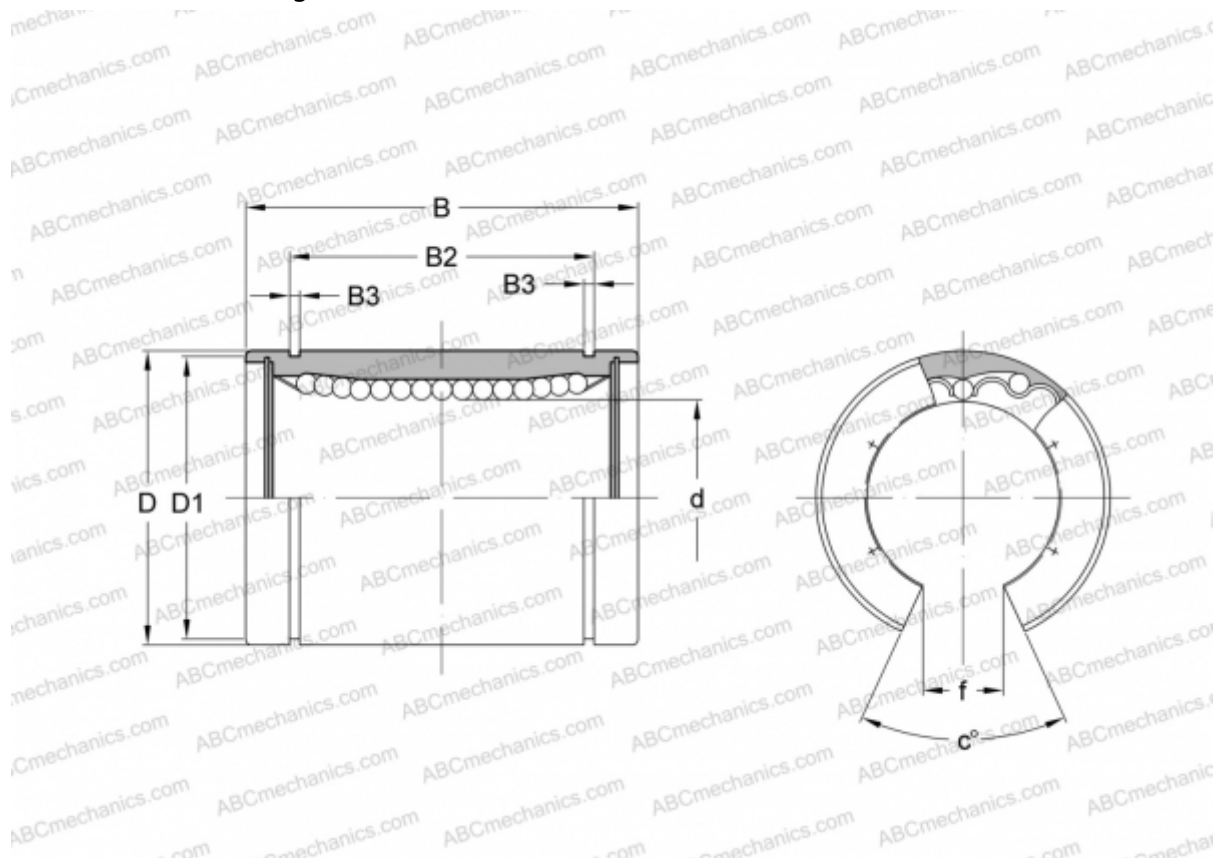

Technical specification

DIMENSIONS, MM

d	12,000
D	22,000
B	32,000
D1	21,000
B2	22,900
B3	1,300
f	7,500
c	78

WEIGHT, KG 0,041

MANUFACTURER [SAMICK](#)