

## LM13 UU OP SAMICK

Linear bushing

TYPE: Shaft guidance systems, Linear bushing, Standard, Open type for support rail, Type LM..OP, Asian standard, Plastic cage (SAMICK)

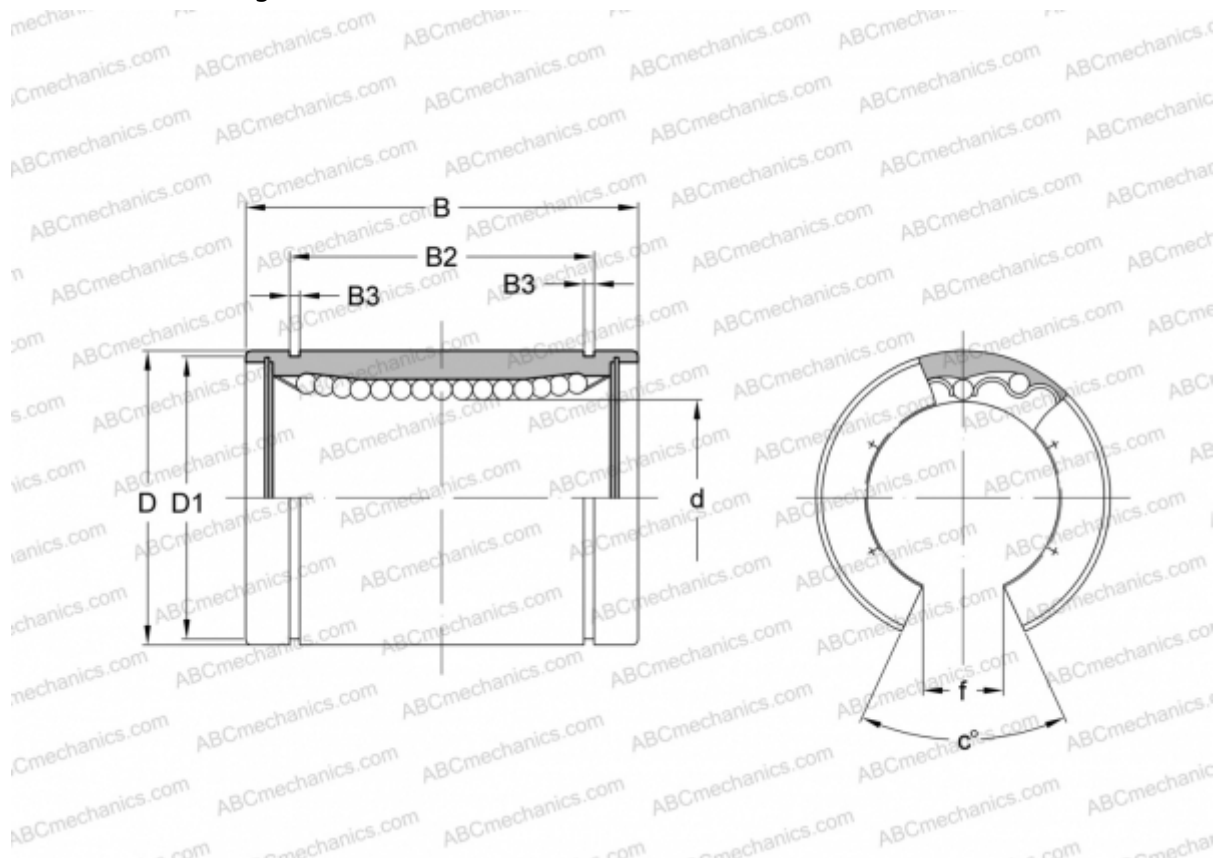

### Technical specification

#### DIMENSIONS, MM

d	13,000
D	23,000
B	32,000
B2	23,000
B3	1,300
c	80

**WEIGHT, KG** 0,043

**MANUFACTURER** [SAMICK](#)