

## LM16 UU OP SAMICK

Linear bushing

TYPE: Shaft guidance systems, Linear bushing, Standard, Open type for support rail, Type LM..OP, Asian standard, Plastic cage (SAMICK)

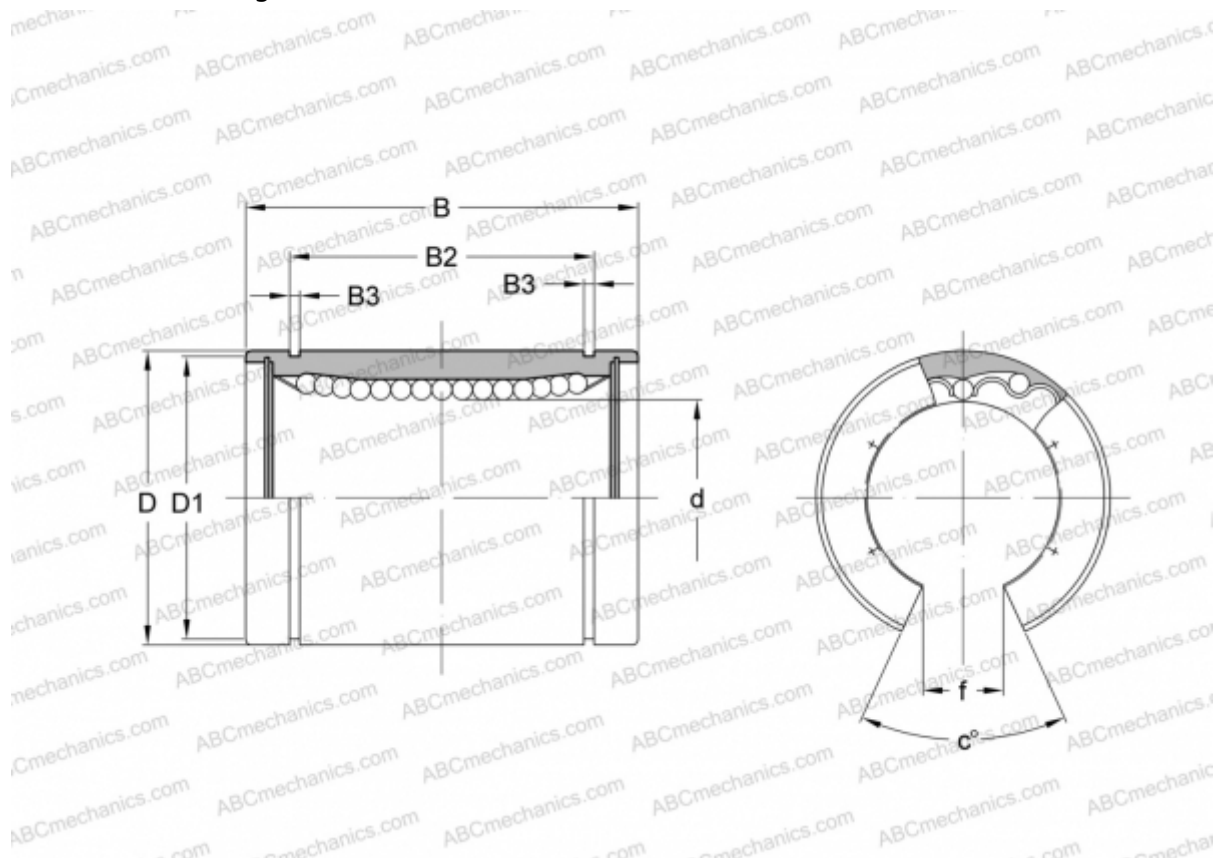

### Technical specification

#### DIMENSIONS, MM

d	16,000
D	28,000
B	37,000
B2	26,500
B3	1,600
c	80

**WEIGHT, KG** 0,069

**MANUFACTURER** [SAMICK](#)