

LM30 UU OP SAMICK

Linear bushing

TYPE: Shaft guidance systems, Linear bushing, Standard, Open type for support rail, Type LM..OP, Asian standard, Plastic cage (SAMICK)

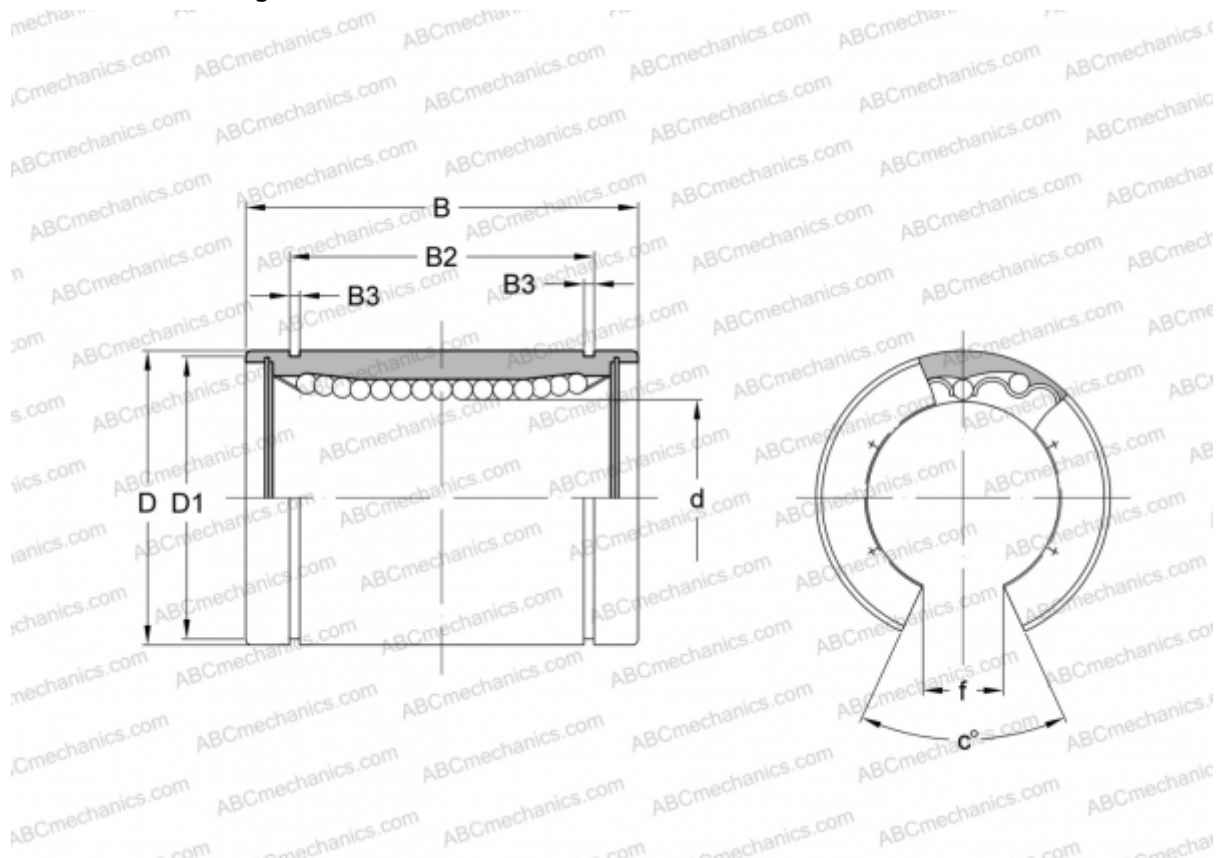

Technical specification

DIMENSIONS, MM

d	30,000
D	45,000
B	64,000
B2	44,500
B3	1,850
c	50

WEIGHT, KG 0,250

MANUFACTURER [SAMICK](#)