

LM35 UU OP SAMICK

Linear bushing

TYPE: Shaft guidance systems, Linear bushing, Standard, Open type for support rail, Type LM..OP, Asian standard, Plastic cage (SAMICK)

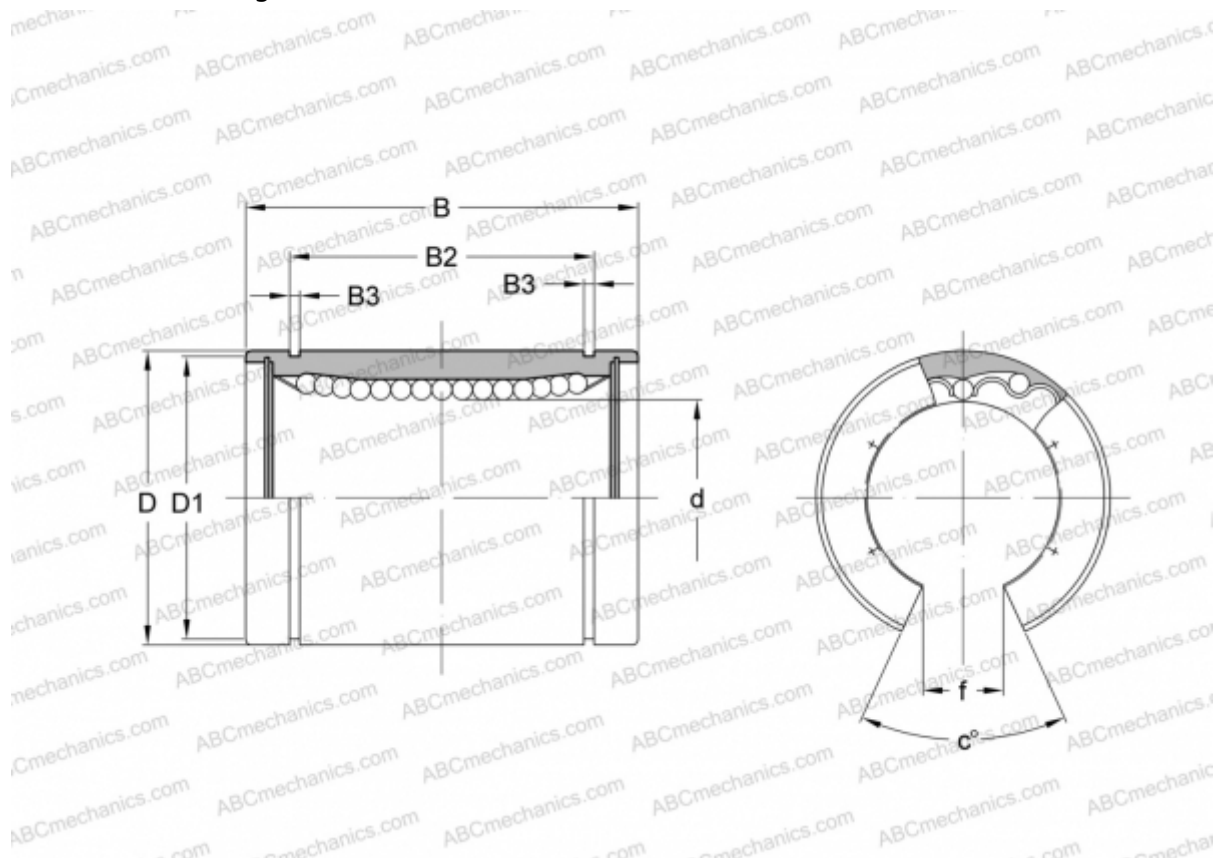

Technical specification

DIMENSIONS, MM

d	35,000
D	52,000
B	70,000
B2	49,500
B3	2,100
c	50

WEIGHT, KG 0,390

MANUFACTURER [SAMICK](http://www.samick.com)