

LM40 UU OP SAMICK

Linear bushing

TYPE: Shaft guidance systems, Linear bushing, Standard, Open type for support rail, Type LM..OP, Asian standard, Plastic cage (SAMICK)

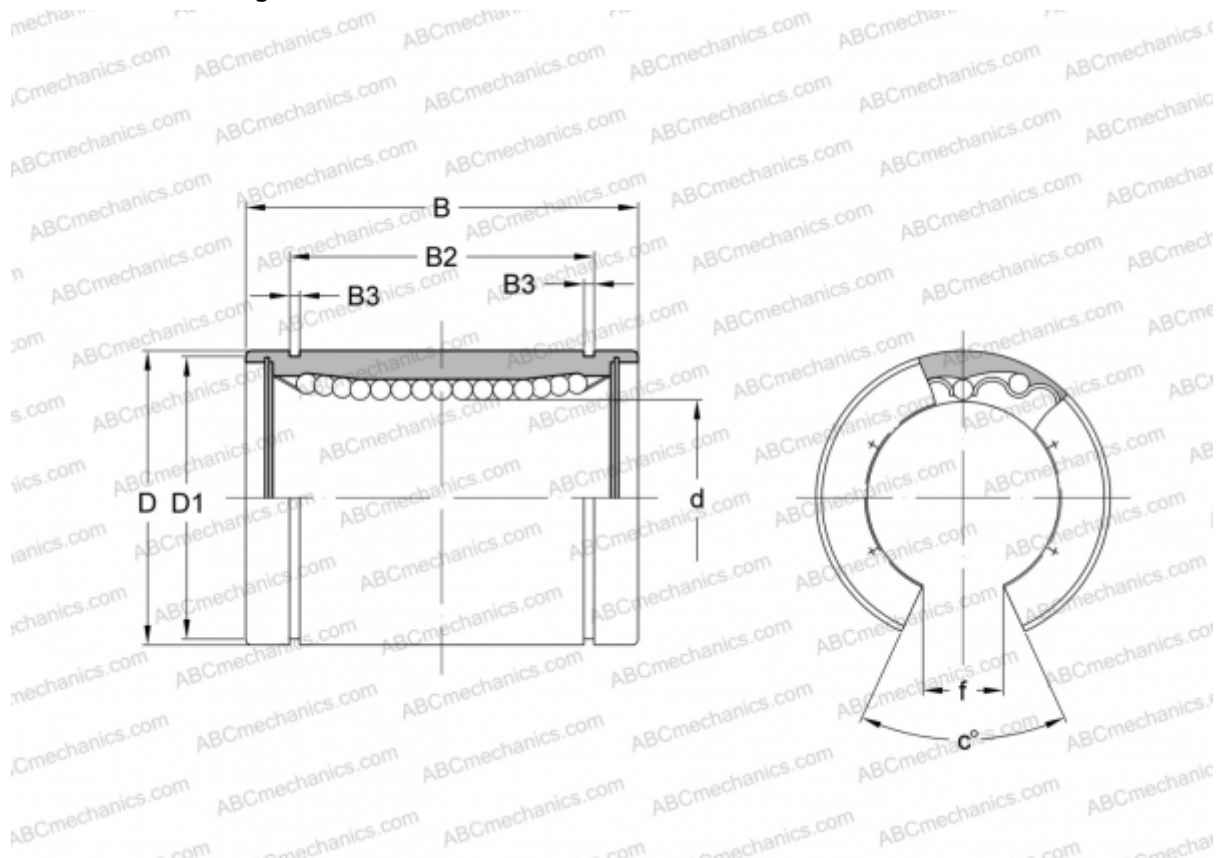

Technical specification

DIMENSIONS, MM

d	40,000
D	60,000
B	80,000
B2	60,500
B3	2,100
c	50

WEIGHT, KG 0,585

MANUFACTURER [SAMICK](http://www.samick.com)