

LM50 UU OP SAMICK

Linear bushing

TYPE: Shaft guidance systems, Linear bushing, Standard, Open type for support rail, Type LM..OP, Asian standard, Plastic cage (SAMICK)

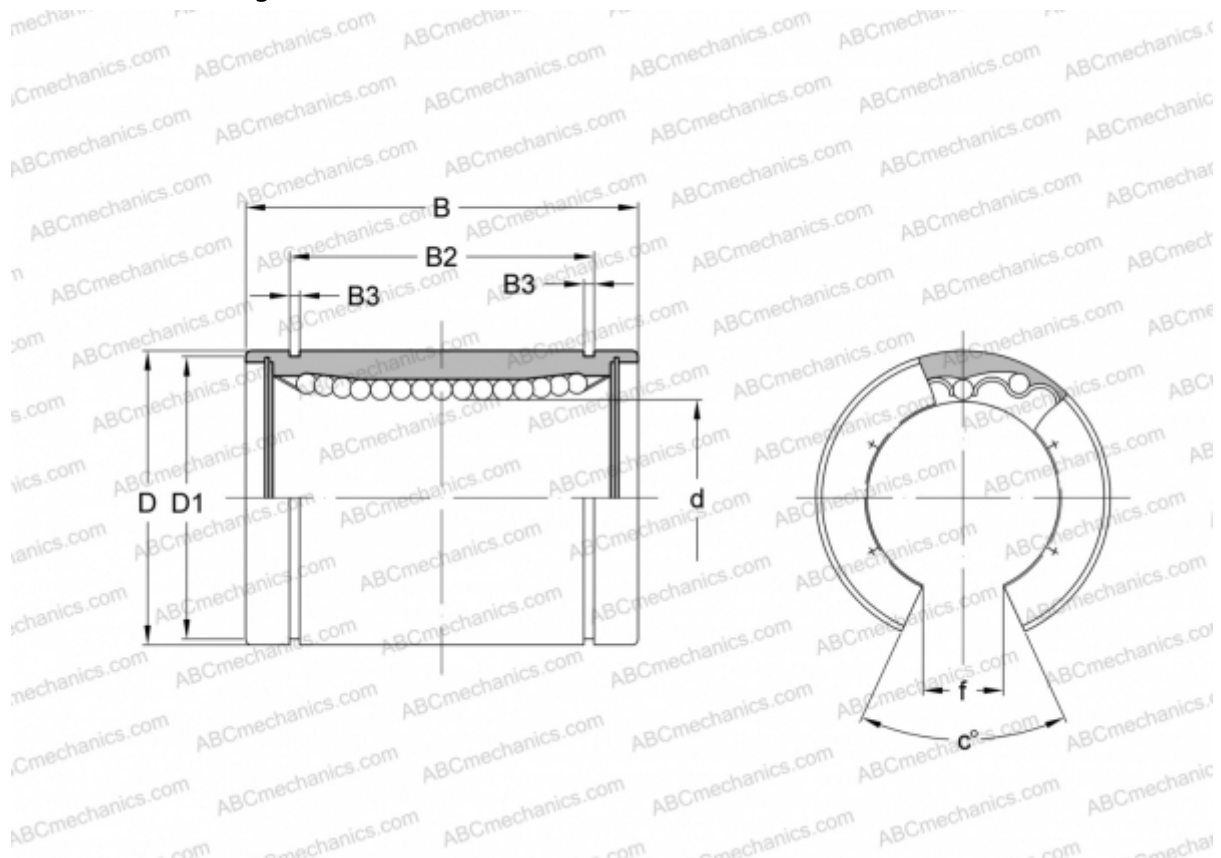

Technical specification

DIMENSIONS, MM

d	50,000
D	80,000
B	100,000
B2	74,000
B3	2,600
c	50

WEIGHT, KG 1,580

MANUFACTURER [SAMICK](#)