

LMF20 UU SAMICK

Linear bushing

TYPE: Shaft guidance systems, Linear bushing, With flange, Circular type, Type LMF, Asian standard, Plastic cage (SAMICK)

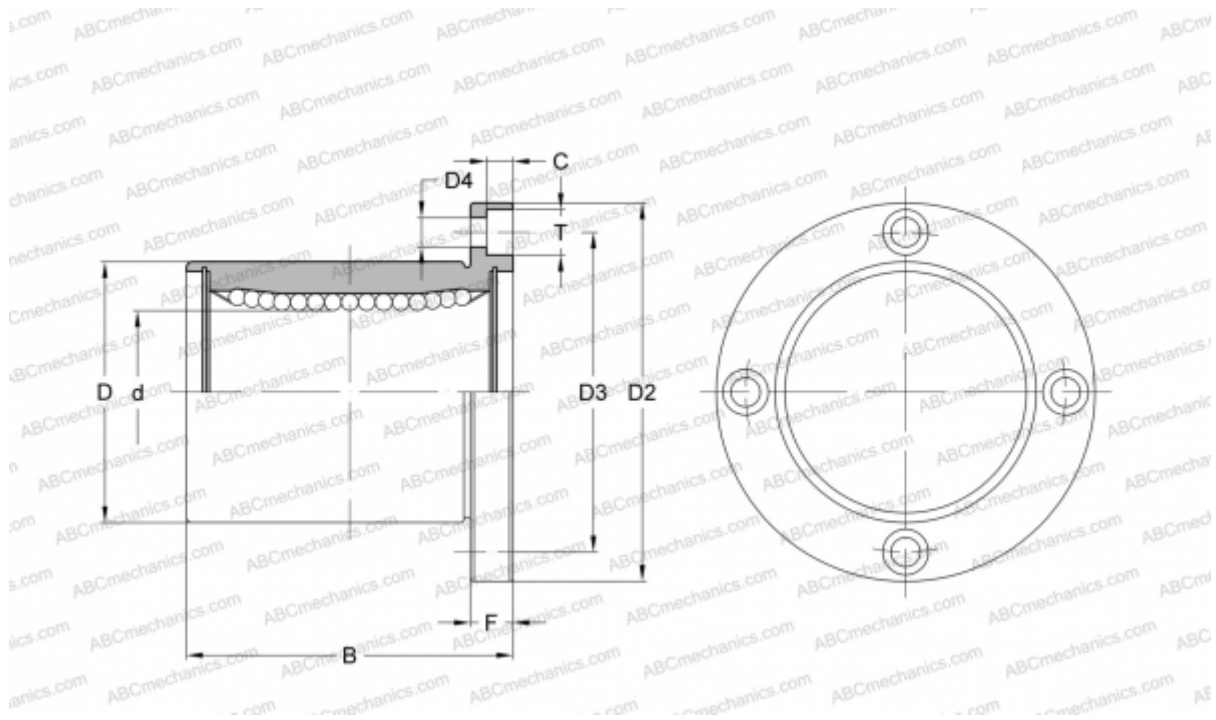

Technical specification

DIMENSIONS, MM

d	20,000
D	32,000
B	42,000
D2	54,000
D3	43,000
D4	5,500
T	9,500
C	5,400
F	8

WEIGHT, KG 0,180

MANUFACTURER [SAMICK](#)