

## LMF30 UU SAMICK

Linear bushing

TYPE: Shaft guidance systems, Linear bushing, With flange, Circular type, Type LMF, Asian standard, Plastic cage (SAMICK)

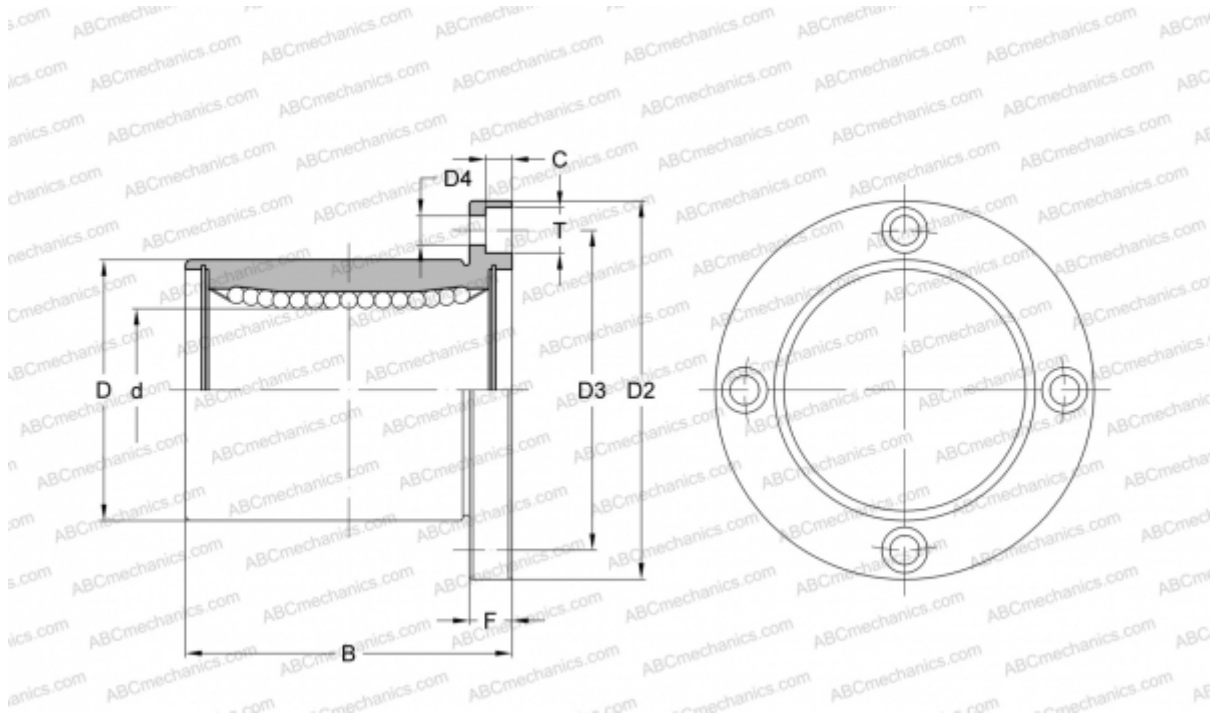

### Technical specification

#### DIMENSIONS, MM

d	30,000
D	45,000
B	64,000
D2	74,000
D3	60,000
D4	6,600
T	11,000
C	6,500
F	10

**WEIGHT, KG** 0,460

**MANUFACTURER** [SAMICK](#)