

LMEF40L UU SAMICK

Linear bushing

TYPE: Shaft guidance systems, Linear bushing, With flange, Circular type, double length, Type LMEF..L, European standard, Plastic cage (SAMICK)

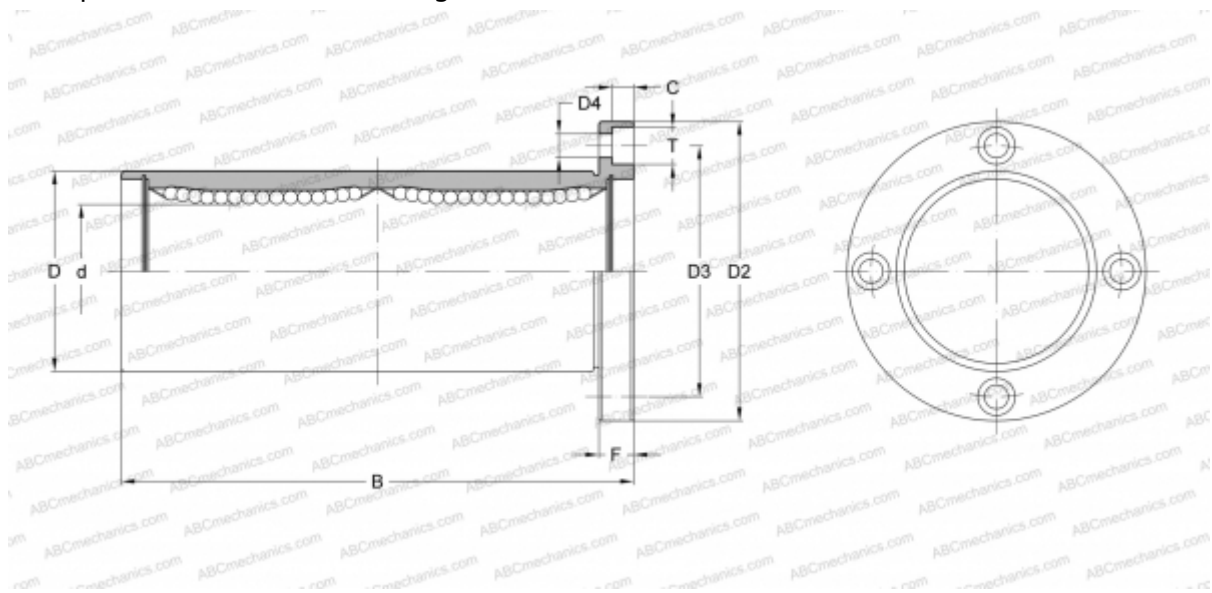

Technical specification

DIMENSIONS, MM

d	40,000
D	62,000
B	154,000
D2	98,000
D3	80,000
D4	9,000
T	14,000
C	8,600
F	13

WEIGHT, KG 1,560

MANUFACTURER [SAMICK](http://www.samick.com)