

LMF8L UU SAMICK

Linear bushing

TYPE: Shaft guidance systems, Linear bushing, With flange, Circular type, double length, Type LMF..L, Asian standard, Plastic cage (SAMICK)

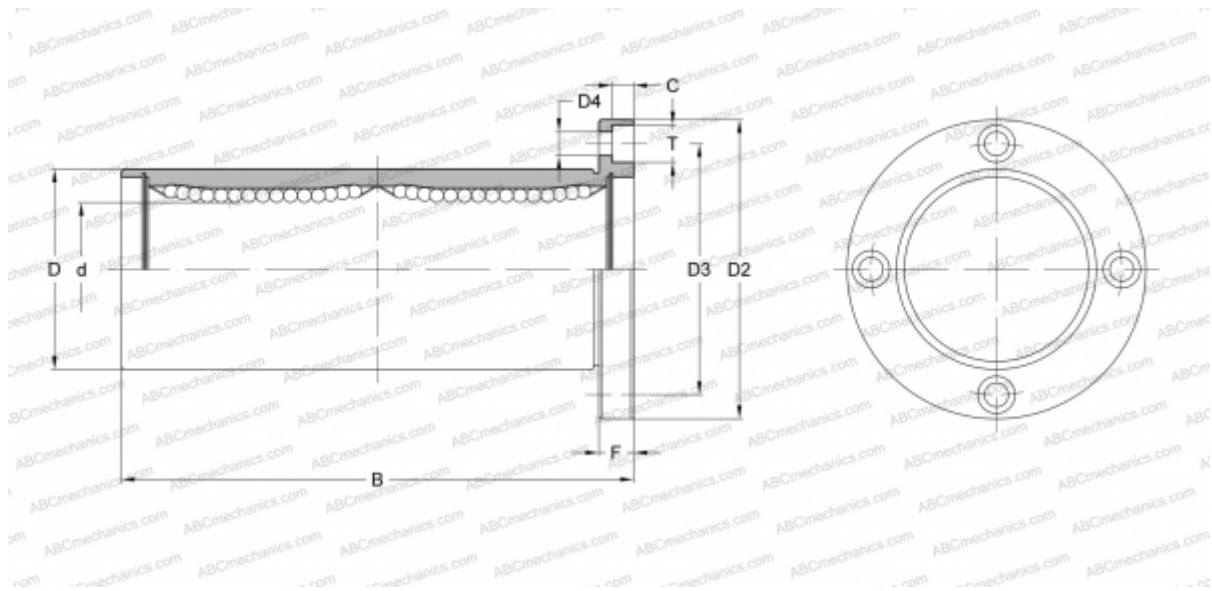

Technical specification

DIMENSIONS, MM

d	8,000
D	15,000
B	45,000
D2	32,000
D3	24,000
D4	3,400
T	6,500
C	3,300
F	5

WEIGHT, KG 0,053

MANUFACTURER [SAMICK](http://www.samick.com)