

LMF12L UU SAMICK

Linear bushing

TYPE: Shaft guidance systems, Linear bushing, With flange, Circular type, double length, Type LMF..L, Asian standard, Plastic cage (SAMICK)

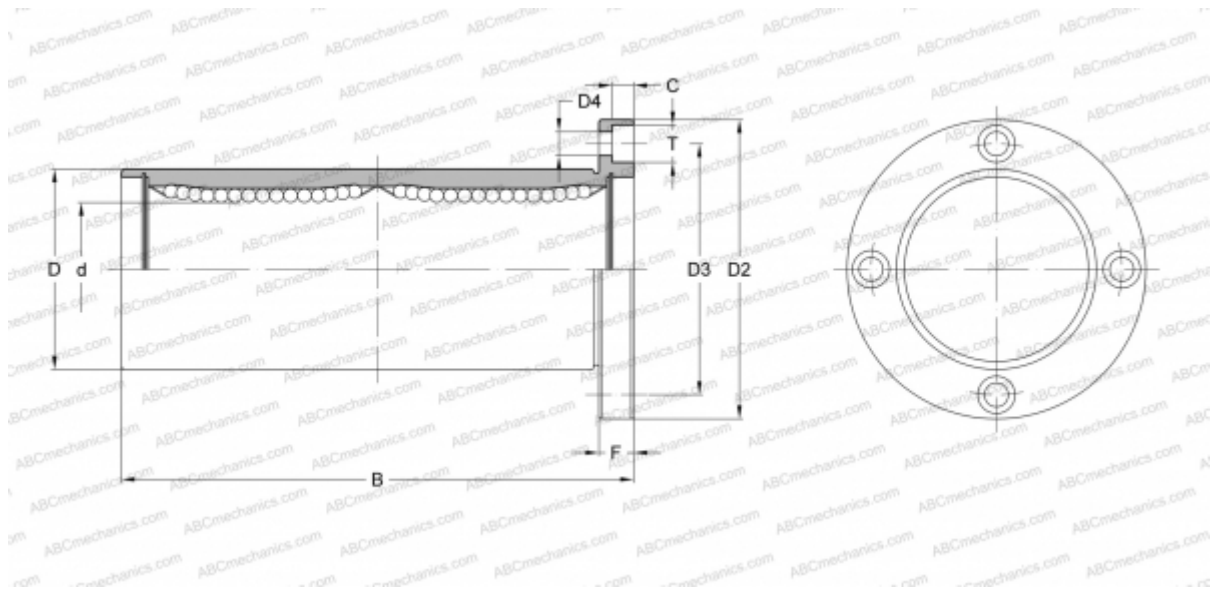

Technical specification

DIMENSIONS, MM

d	12,000
D	21,000
B	57,000
D2	42,000
D3	32,000
D4	4,500
T	8,000
C	4,400
F	6

WEIGHT, KG 0,100

MANUFACTURER [SAMICK](http://www.samick.com)